

A Short Course on Quantum Matrices

MITSUHIRO TAKEUCHI
NOTES TAKEN BY BERND STRÜBER

CONTENTS

| | |
|---|-----|
| Introduction | 383 |
| 1. (2×2) q -Matrices | 385 |
| 2. q -Matrices and Kauffman's Bracket Polynomial | 387 |
| 3. Powers of (2×2) q -Matrices | 390 |
| 4. The Quantum Linear Groups $GL_q(n)$ and $SL_q(n)$ | 391 |
| 5. A q -Analogue of the Cayley–Hamilton Theorem | 396 |
| 6. The R -Matrix R_q and the Homfly Polynomial | 398 |
| 7. Duality with the Quantized Enveloping Algebra $U_q(\mathfrak{sl}_n)$ | 403 |
| 8. Skew Primitive Elements | 408 |
| 9. Group Homomorphisms $SL_q(n) \rightarrow GL_q(m)$ | 412 |
| 10. The 2-Parameter Quantization | 417 |
| 11. The q -Schur Algebra and the Hecke Algebra | 419 |
| 12. Cocycle Deformations | 422 |
| 13. (2×2) R -Matrices | 427 |
| 14. The Quantum Frobenius Map and Related Topics | 428 |
| 15. References and Notes | 432 |

Introduction

The notion of quantum matrices has interesting and important connections with various topics in mathematics such as quantum group theory, Hopf algebra theory, braided tensor categories, knot and link invariants, the Yang–Baxter equation, representation theory and so on.

This course is an introduction to quantum groups. I have made an effort to have the exposition as elementary as possible. I intended to talk in some informal way, and did not intend to give detailed proofs. The present notes have somewhat more formal and rigorous flavor than the actual lectures, in

These notes are based on a course given at University of Munich in Summer, 1997 with arrangements by H.-J. Schneider and financial support from the Humboldt Foundation and the Graduiertenkolleg of University of Munich.

which I tried to visualize and illustrate connections with knot theory by using transparency sheets.

I begin with introducing 2×2 q -matrices in Section 1. They are characterized in two ways, one by the q -adjoint matrix (Proposition 1.3) and the other by the R -matrix R_q (Proposition 1.6). Each of them admits an interesting interpretation in the theory of knot invariants, and this is illustrated in Section 2 by talking about a basic knot invariant, called Kauffman's bracket polynomial.

The 2×2 q -matrices have the remarkable property that their n -th powers are q^n -matrices. This fact was found around 1991 by several physicists. I reproduce Umeda and Wakayama's elegant proof in Section 3. The first characterization (Proposition 1.3) plays a role in the proof.

General q -matrices of degree n are introduced in Section 4 as well as a brief exposition of fundamental facts involving the R -matrix R_q , the q -symmetric and q -exterior algebras, the q -determinant, the q -adjoint matrix and so on. The q -matrix bialgebra $\mathcal{O}_q(M(n))$ and the coordinate Hopf algebras $\mathcal{O}_q(\mathrm{GL}(n))$ and $\mathcal{O}_q(\mathrm{SL}(n))$ of quantum GL and SL are also considered in this section.

The material of Section 4 leads to a q -analogue of linear algebra. In Section 5, I reproduce J. Zhang's result on a q -analogue of the Cayley–Hamilton theorem which will be one of the most interesting topics in this area.

The R -matrix R_q introduced in Section 4 plays a remarkable role in the construction of the so-called Homfly polynomial which is a two-variable invariant of oriented links. This is illustrated in Section 6 following Kauffman's idea.

In Sections 7 to 9, we talk about some Hopf algebraic properties of $\mathcal{O}_q(\mathrm{GL}(n))$ and $\mathcal{O}_q(\mathrm{SL}(n))$. In Section 7, we talk about the duality of two quantum Hopf algebras $\mathcal{O}_q(\mathrm{SL}(n))$ and $U_q(\mathfrak{sl}_n)$. Details are exposed in case $n = 2$ and q is not a root of unity.

We show how to determine all group-like and skew-primitive elements of $\mathcal{O}_q(\mathrm{GL}(n))^\circ$, the dual Hopf algebra of $\mathcal{O}_q(\mathrm{GL}(n))$, in Section 8. This technical result is used to describe all quantum group homomorphisms $\mathrm{SL}_q(n) \rightarrow \mathrm{GL}_q(m)$ in Section 9. We explain the main result (Theorem 9.13) when q is not a root of unity, since this case is very easy to handle. However, we note that the result is also valid at roots of unity.

These nine sections were delivered in six consecutive lectures in Munich, while the remaining part came out from my rough draft written in Japanese with translation into English by A. Masuoka.

In Section 10, we introduce 2-parameter quantum matrices and construct the bialgebra $\mathcal{O}_{\alpha,\beta}(M(n))$ and the Hopf algebra $\mathcal{O}_{\alpha,\beta}(\mathrm{GL}(n))$ as generalizations of $\mathcal{O}_q(M(n))$ and $\mathcal{O}_q(\mathrm{GL}(n))$. If we take $(\alpha, \beta) = (1, q)$, the Hopf algebra $\mathcal{O}_{1,q}(\mathrm{GL}(n))$ defines the Dipper–Donkin quantum GL whose polynomial representations become equivalent with comodules for $\mathcal{O}_{1,q}(M(n))$. This idea leads to a q -analogue of the Schur algebra which is discussed in Section 11 as well as the Hecke algebra.

Y. Doi has introduced the idea of cocycle deformations of a bialgebra through his study of braided and quadratic bialgebras. The notion of a braided bialgebra is dual to Drinfeld's quasi-triangular bialgebras. These items are explained briefly in Section 12 and I reproduce my own result on determining all cocycle deformations of the bialgebra $\mathcal{O}_{\alpha,\beta}(M(n))$.

This course ends with a short remark on 2×2 R -matrices in Section 13 including my student Suzuki's new results.

These lecture notes were written up by B. Strüber who has made an excellent job, especially when he made my rough drafts and transparency sheets into a formal and rigorous exposition. I thank him most warmly for his efforts. I would also like to thank H.-J. Schneider who invited me to Munich and arranged my lectures.

Section 14 was added after acceptance of this exposition in this publication in order to update the contents. I introduce E. Müller's and E. Letzter's current results concerning the quantum Frobenius map in this addendum. Finally, Section 15 is a short annotated bibliography.

1. (2×2) q -Matrices

Throughout this paper, let k be a fixed base field, $k^\times := k \setminus \{0\}$ and $q \in k^\times$.

DEFINITION 1.1 (q -MATRICES). Let $A = \begin{pmatrix} a & b \\ c & d \end{pmatrix}$ be a (2×2) -matrix over some k -algebra. We call A a q -matrix if its entries satisfy the following relations:

$$\begin{aligned} ba &= qab, & dc &= qcd, \\ ca &= qac, & db &= qbd, \\ cb &= bc, & da - ad &= (q - q^{-1})bc. \end{aligned}$$

(The last relation implies $ad - q^{-1}bc = da - qbc$.) We call this expression the q -determinant of A and denote it by $|A|_q$ (for $q = 1$, this is just the usual determinant).

DEFINITION 1.2. The q -adjoint matrix of any matrix A is defined as

$$\tilde{A} := \begin{pmatrix} d & -qb \\ -q^{-1}c & a \end{pmatrix}.$$

It is easily verified that \tilde{A} is a q^{-1} -matrix, if A is a q -matrix.

PROPOSITION 1.3. (a) For any q -matrix A , we have:

$$|\tilde{A}|_{q^{-1}} = |A|_q, \quad \tilde{A} = \begin{pmatrix} & q \\ -1 & \end{pmatrix} A^t \begin{pmatrix} q^{-1} & \\ & -1 \end{pmatrix}.$$

(b) A matrix A is a q -matrix, with $\delta = |A|_q$, if and only if $A\tilde{A} = \delta I = \tilde{A}A$.

PROOF. Part (a) is immediate. Part (b) follows by comparing the matrix coefficients of

$$A\tilde{A} = \begin{pmatrix} ad - q^{-1}bc & ba - qab \\ cd - q^{-1}dc & da - qcb \end{pmatrix}, \quad \tilde{A}A = \begin{pmatrix} da - qbc & db - qbd \\ -q^{-1}ca + ac & ad - q^{-1}cb \end{pmatrix}.$$

□

COROLLARY 1.4. *Let A, B be q -matrices over the same algebra.*

- (a) *The q -determinant δ of A commutes with the entries of A .*
- (b) *If δ is invertible then A is invertible and $A^{-1} = \delta^{-1}\tilde{A}$, which is a q^{-1} -matrix, with determinant*

$$|A^{-1}|_{q^{-1}} = \delta^{-2}|\tilde{A}|_{q^{-1}} = \delta^{-1} = |A|_q^{-1}.$$

- (c) *If every entry of A commutes with every entry of B , then AB is a q -matrix, with $|AB|_q = |A|_q|B|_q$.*

PROOF. Part (a) follows from $\delta A = A\tilde{A}A = A\delta$. Part (b) is easily obtained from Proposition 1.3. To show (c), observe that

$$(\widetilde{AB}) = \binom{-1}{-1}^q (AB)^t \binom{-1}{q^{-1}} = \binom{-1}{-1}^q B^t A^t \binom{-1}{q^{-1}} = \tilde{B}\tilde{A}.$$

Hence, writing $\delta := |A|_q$ and $\delta' := |B|_q$, we get:

$$AB\widetilde{AB} = AB\tilde{B}\tilde{A} = A\delta'\tilde{A} = A\tilde{A}\delta' = \delta\delta'I.$$

Similarly, $\widetilde{ABAB} = \delta\delta'I$. This proves the claim. □

We give an equivalent description of q -matrices, in terms of “R-matrices”.

DEFINITION 1.5. In the following, we identify $M_4(k)$ with $M_2(k) \otimes M_2(k)$, by

$$\mathbb{E}_{(ik),(j\ell)} = \mathbb{E}_{ij} \otimes \mathbb{E}_{k\ell}.$$

For a (2×2) -matrix $A = (a_{ij})$ over some k -algebra, we write

$$A^{(2)} := (a_{ij}a_{k\ell})_{(ik),(j\ell)},$$

which is a (4×4) -matrix with rows and columns indexed by (11), (12), (21), (22).

We write:

$$R_q := \begin{pmatrix} q & 0 & 0 & 0 \\ 0 & 0 & 1 & 0 \\ 0 & 1 & q - q^{-1} & 0 \\ 0 & 0 & 0 & q \end{pmatrix}.$$

PROPOSITION 1.6 (THE R-MATRIX R_q AND q -MATRICES). (a) *R_q is invertible and satisfies the following equation in $M_2(k) \otimes M_2(k) \otimes M_2(k)$ (called the braid relation or the Yang–Baxter equation):*

$$(R_q \otimes I)(I \otimes R_q)(R_q \otimes I) = (I \otimes R_q)(R_q \otimes I)(I \otimes R_q). \tag{1-1}$$

- (b) *We have $(R_q - qI)(R_q + q^{-1}I) = 0$.*
- (c) *A (2×2) -matrix A is a q -matrix if and only if $A^{(2)}R_q = R_qA^{(2)}$.*

The proof is easy and straightforward, but tedious, so we omit it.

2. q -Matrices and Kauffman's Bracket Polynomial

There is a close relation between R -matrices and polynomials associated to diagrams of links.

It is not easy to give a formal definition of a *link diagram*, so we illustrate this concept with some examples:

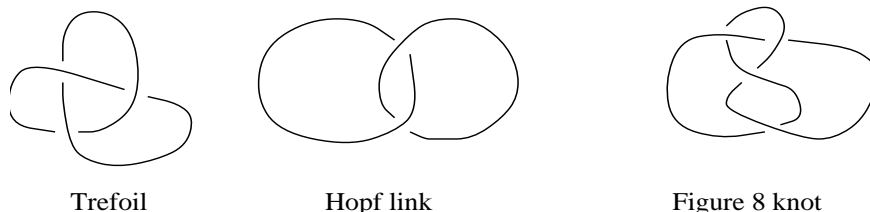

Figure 1. Some link diagrams

DEFINITION 2.1 (KAUFFMAN'S BRACKET POLYNOMIAL). Let L be a link diagram. Kauffman's bracket polynomial $\langle L \rangle \in \mathbb{Z}[t, t^{-1}]$ is defined by the following rules:

- (a) $\langle \begin{array}{c} \diagup \\ \diagdown \end{array} \rangle = t \langle \begin{array}{c} \diagdown \\ \diagdown \end{array} \rangle + t^{-1} \langle \begin{array}{c} \diagdown \\ \diagup \end{array} \rangle$;
- (b) $\langle \bigcirc \dots \bigcirc \rangle = d^n$, for $d := -t^2 - t^{-2}$ (for n circles).

It is an easy exercise to determine the bracket polynomial for a given link diagram, using these rules. We have, for example

$$\langle \text{Hopf link} \rangle = (-t^4 - t^{-4})d, \quad \langle \text{Trefoil} \rangle = (-t^5 - t^{-3} + t^{-9})d.$$

Kauffman's polynomial is invariant under operations which transform a link diagram in another diagram of "the same" link.

The operations shown in Figure 2 are called *Reidemeister moves* of type II and III, respectively.

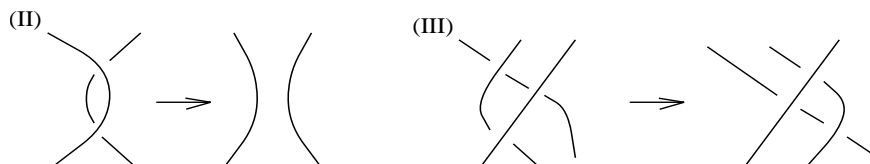

Figure 2. Reidemeister moves of type II and III

PROPOSITION 2.2. *Kauffman's bracket polynomial is invariant under Reidemeister moves of type II and III, i.e., under regular isotopy.*

PROOF. We give the proof for type II, the same method applies to type III. By replacing successively the crossings $\langle \begin{array}{c} \diagup \\ \diagdown \end{array} \rangle$ by either $\langle \begin{array}{c} \diagdown \\ \diagdown \end{array} \rangle$ or $\langle \begin{array}{c} \diagdown \\ \diagup \end{array} \rangle$, we get the *skein tree* shown in Figure 3.

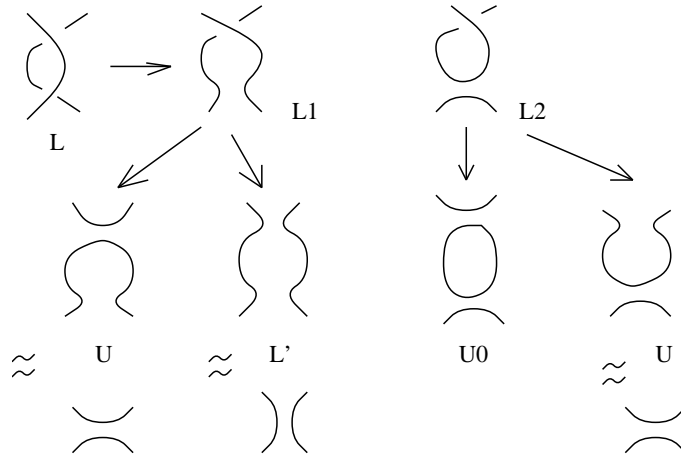

Figure 3. Skein tree for Reidemeister move II

Now we can apply the rules of Definition 2.1 to get the desired result:

$$\begin{aligned}
 \langle L \rangle &= t \langle L1 \rangle + t^{-1} \langle L2 \rangle \\
 &= t(t \langle U \rangle + t^{-1} \langle L' \rangle) + t^{-1}(t \langle U0 \rangle + t^{-1} \langle U \rangle) \\
 &= (t^2 + t^{-2}) \langle U \rangle + \langle L' \rangle + d \langle U \rangle = \langle L' \rangle. \quad \square
 \end{aligned}$$

There is another method to compute $\langle L \rangle$, closely related to the R -matrix R_q .

Any link diagram L can be decomposed into *elements* of the form \wr (arc), \cap (cap), \cup (cup), \swarrow , \searrow (crossings). Consider the following example:

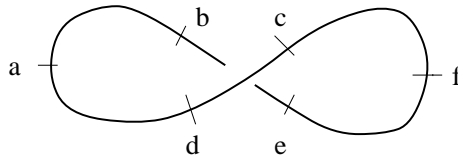

Figure 4. Decomposition of the link diagram of ∞

The bracket polynomial $\langle \infty \rangle$ can be calculated as

$$\sum \langle a \cap b \rangle \langle a \cup d \rangle \langle d \swarrow_e \searrow_c \rangle \langle c \cap f \rangle \langle e \cup f \rangle,$$

where a, b, c, d, e, f range over $\{1, 2\}$, if one associates suitable values to the factors $\langle C \rangle$, where C denotes a labelled element of the link diagram.

THEOREM 2.3 (KAUFFMAN). *The bracket polynomial $\langle L \rangle$ of a link diagram L is*

$$\langle L \rangle = \sum \left(\prod (\langle C \rangle \mid C \text{ is a labelled element of } L \mid \text{all labels in } \{1, 2\}) \right),$$

where $\langle C \rangle$, for a labelled element C of L , is defined as

$$\begin{aligned} \langle {}^a \cup_b \rangle &:= \delta_{ab}, \\ \langle {}_a \cap_b \rangle &:= \langle {}^a \cup^b \rangle := M_{ab}, \\ \langle {}^a \setminus_b \rangle &:= t\delta_{ac}\delta_{bd} + t^{-1}M_{ab}M_{cd} := R_{cd}^{ab}, \\ \langle {}_a \setminus_b \rangle &:= t^{-1}\delta_{ac}\delta_{bd} + tM_{ab}M_{cd} := \overline{R}_{cd}^{ab}, \end{aligned}$$

with $M := \begin{pmatrix} 0 & it \\ -it^{-1} & 0 \end{pmatrix}$ and $i^2 = -1$.

DEFINITION 2.4. Let $R := (R_{cd}^{ab})_{(ab),(cd)}$ denote the (4×4) -matrix, with entries in $\mathbb{Z}[t, t^{-1}]$, defined by

$$R_{cd}^{ab} := t\delta_{ac}\delta_{bd} + t^{-1}M_{ab}M_{cd} = \langle {}^a \setminus_b \rangle.$$

Hence,

$$R = \begin{pmatrix} t & 0 & 0 & 0 \\ 0 & 0 & t^{-1} & 0 \\ 0 & t^{-1} & t - t^{-3} & 0 \\ 0 & 0 & 0 & t \end{pmatrix},$$

which means that for $q := t^2$, we have (cf. Definition 1.5)

$$R = t^{-1}R_q. \tag{2-1}$$

Recall that a matrix A is a q -matrix if and only if $A^{(2)}$ commutes with R_q (Proposition 1.6(c)). This can be interpreted as a certain compatibility condition with link diagrams. In the following, we allow link diagrams to contain “nodes”, labelled with matrices in some algebra.

DEFINITION 2.5. Let $A = (A_{ij})$ be a (2×2) -matrix with entries in some algebra K . By defining

$$\langle \begin{array}{c} | \\ \bigcirc \text{ A} \\ | \end{array} \begin{array}{c} | \\ \bigcirc \text{ A} \\ | \end{array} \rangle = \sum_{i,j,k,l \in \{1,2\}} \left\langle \begin{array}{c|c} i & k \\ \hline j & l \end{array} \right\rangle A_{ij}A_{kl}, \tag{2-2}$$

we associate a bracket polynomial (in $K[t, t^{-1}]$) to link diagrams which may contain nodes with the matrix A .

We examine the invariance conditions given on Figure 5.

PROPOSITION 2.6. Let $q := t^2$ and let A be any matrix with entries in some k -algebra.

- (a) Conditions (1) and (2) are satisfied if and only if A is a q -matrix, with $|A|_q = 1$.
- (b) Condition (3), condition (4) and the condition that A is a q -matrix are equivalent.

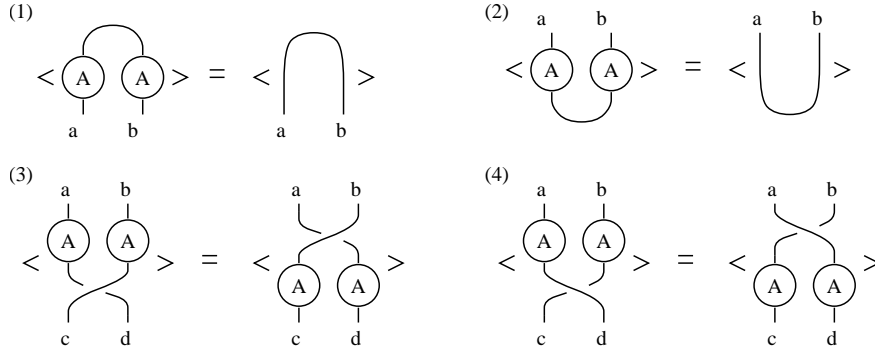

Figure 5. Invariance conditions for link diagrams with nodes

PROOF. (a) Using (2–2) and Kauffman’s theorem, the left hand side of condition (1) is

$$\sum_{i,j \in \{1,2\}} A_{ia} M_{ij} A_{jb} = (A^t M A)_{ab}.$$

Hence, (1) is satisfied if and only if $A^t M A = M$. Now M^2 is the identity matrix and $\tilde{A} = M A^t M$. Therefore, condition (1) is equivalent to $\tilde{A} A = I$.

It is shown similarly that (2) is equivalent to $A \tilde{A} = I$. Now part (a) follows from Proposition 1.3 (b).

(b) It easy to check that (3) is equivalent to the condition that $A^{(2)}$ commutes with R , and that (4) is equivalent to $\bar{R} = R^{-1}$. Recall that $R = t^{-1} R_q$, by (2–1). Now (b) follows from Proposition 1.6(c). \square

Proposition 2.6 means that the bracket polynomial is invariant under the action of the quantum group $SL_q(2)$, with $q := t^2$.

3. Powers of (2×2) q -Matrices

THEOREM 3.1 (POWERS OF (2×2) q -MATRICES). *If A is a (2×2) q -matrix then A^n is a q^n -matrix, and its q^n -determinant is:*

$$|A^n|_{q^n} = |A|_q^n.$$

PROOF (Umeda, Wakayama, 1993). Let $A = \begin{pmatrix} a & b \\ c & d \end{pmatrix}$ be a (2×2) q -matrix and $\mathcal{J} := \begin{pmatrix} 1 & \\ & q \end{pmatrix}$. Writing $\tau := a + q^{-1}d$ and $\delta := |A|_q$, it is easy to check that

$$A^2 = \tau \mathcal{J} A - q^{-1} \delta \mathcal{J}^2. \tag{3-1}$$

Since the transpose A^t is a q -matrix as well, with the same q -determinant, it follows that

$$(A^t)^2 = \tau \mathcal{J} A^t - q^{-1} \delta \mathcal{J}^2. \tag{3-2}$$

We show by induction that for all $n \geq 0$:

$$(A^t)^n = \mathcal{J}^{n-1} (A^n)^t \mathcal{J}^{1-n}. \tag{3-3}$$

The cases $n = 0, 1$ are obvious. Assume (3-3) is true for $n, n + 1$. Then

$$\begin{aligned}
 (A^t)^{n+2} &\stackrel{(3-2)}{=} \tau \mathcal{J}(A^t)^{n+1} - q^{-1} \delta \mathcal{J}^2 (A^t)^n \\
 &\stackrel{(3-3)}{=} \tau \mathcal{J}^{n+1} (A^{n+1})^t \mathcal{J}^{-n} - q^{-1} \delta \mathcal{J}^{n+1} (A^n)^t \mathcal{J}^{1-n} \\
 &= \mathcal{J}^{n+1} \underbrace{(\tau (A^{n+1})^t \mathcal{J} - q^{-1} \delta (A^n)^t \mathcal{J}^2)}_{(*)} \mathcal{J}^{-1-n}. \tag{3-4}
 \end{aligned}$$

From (3-1), it follows that

$$A^{n+2} = \tau \mathcal{J} A^{n+1} - q^{-1} \delta \mathcal{J}^2 A^n.$$

Hence, the expression (*) is equal to $(A^{n+2})^t$ and (3-4) implies

$$(A^t)^{n+2} = \mathcal{J}^{n+1} (A^{n+2})^t \mathcal{J}^{-1-n},$$

which proves the induction step.

By Proposition 1.3, we have $A\tilde{A} = \tilde{A}A = \delta I$. Since δ commutes with the entries of A , we get

$$A^n \tilde{A}^n = \tilde{A}^n A^n = \delta^n I. \tag{3-5}$$

It follows that

$$\begin{aligned}
 \tilde{A}^n &= \begin{pmatrix} & q \\ -1 & \end{pmatrix} (A^t)^n \begin{pmatrix} & -1 \\ q^{-1} & \end{pmatrix} \\
 &\stackrel{(3-3)}{=} \begin{pmatrix} & q \\ -1 & \end{pmatrix} \mathcal{J}^{n-1} (A^n)^t \mathcal{J}^{1-n} \begin{pmatrix} & -1 \\ q^{-1} & \end{pmatrix} \\
 &= \begin{pmatrix} & q^n \\ -1 & \end{pmatrix} (A^n)^t \begin{pmatrix} & -1 \\ q^{-n} & \end{pmatrix} = \widetilde{(A^n)}.
 \end{aligned}$$

Using (3-5), this implies

$$A^n \widetilde{(A^n)} = \widetilde{(A^n)} A^n = \delta^n I,$$

which means A^n is a q^n -matrix, with q^n -determinant δ^n (cf. Proposition 1.3(b)). □

4. The Quantum Linear Groups $GL_q(n)$ and $SL_q(n)$

DEFINITION 4.1 ($(n \times n)$ q -MATRICES). Let $A = (a_{ij})$ be an $(n \times n)$ -matrix, with entries in some k -algebra. We call A a q -matrix, if every (2×2) -minor of A is a q -matrix.

A (2×2) -minor of A is a (2×2) -matrix obtained from A by removing some rows and columns.

Similar to Proposition 1.6, we can describe $(n \times n)$ q -matrices using an R -matrix. The next definition generalizes Definition 1.5.

DEFINITION 4.2. We identify $M_{n^2}(k)$ with $M_n(k) \otimes M_n(k)$, by

$$\mathbb{E}_{(ik),(j\ell)} = \mathbb{E}_{ij} \otimes \mathbb{E}_{k\ell}.$$

For an $(n \times n)$ -matrix $A = (a_{ij})$ over some k -algebra, we write

$$A^{(2)} := (a_{ij}a_{k\ell})_{(ik),(j\ell)},$$

which is an $(n^2 \times n^2)$ -matrix.

The matrix $R_q \in M_n(k) \otimes M_n(k)$ is given by

$$R_q := q \sum_i \mathbb{E}_{ii} \otimes \mathbb{E}_{ii} + \sum_{i \neq j} \mathbb{E}_{ij} \otimes \mathbb{E}_{ji} + (q - q^{-1}) \sum_{i < j} \mathbb{E}_{jj} \otimes \mathbb{E}_{ii}.$$

PROPOSITION 4.3 (THE R-MATRIX R_q AND q -MATRICES). (a) R_q is invertible and satisfies the Yang-Baxter equation (1-1).

(b) We have $(R_q - qI)(R_q + q^{-1}I) = 0$.

(c) An $(n \times n)$ -matrix A is a q -matrix if and only if $A^{(2)}R_q = R_qA^{(2)}$.

We omit the proof since it is easy but tedious.

COROLLARY 4.4. Let A, B be $(n \times n)$ q -matrices (over the same algebra), such that every entry of A commutes with every entry of B . Then AB is again a q -matrix.

PROOF. Since $(AB)^{(2)} = A^{(2)}B^{(2)}$, the claim follows from Proposition 4.3. \square

DEFINITION 4.5 (THE q -MATRIX BIALGEBRA). Let $M := \mathcal{O}_q(M(n))$ denote the k -algebra generated by elements x_{ij} ($1 \leq i, j \leq n$), subject to the relations that $X := (x_{ij})_{i,j}$ is a q -matrix. We call M the q -matrix bialgebra.

PROPOSITION 4.6. The following algebra maps make M a bialgebra:

$$\begin{aligned} \Delta : M &\rightarrow M \otimes M, & x_{ij} &\mapsto \sum_{s=1}^n x_{is} \otimes x_{sj}, \\ \varepsilon : M &\rightarrow k, & x_{ij} &\mapsto \delta_{ij}. \end{aligned}$$

PROOF. The matrices $A := (x_{ij} \otimes 1)_{i,j}$ and $B := (1 \otimes x_{ij})_{i,j}$ are both q -matrices over $M \otimes M$. Since every entry of A commutes with every entry of B , the product $AB = (\Delta(x_{ij}))_{i,j}$ is also a q -matrix. Hence, Δ is a well-defined algebra map.

Since the identity matrix is a q -matrix, ε is well-defined, too. The bialgebra axioms are easily checked on the generators. \square

PROPOSITION 4.7 (THE ALGEBRAIC STRUCTURE OF M). The algebra M is an integral domain, which is non-commutative, if $n > 1$ and $q \neq 1$.

It is a polynomial algebra in x_{11}, \dots, x_{nn} , i.e. the ordered monomials in x_{11}, \dots, x_{nn} (with respect to any total ordering) form a basis of M .

The proof is not easy and requires some calculations. We omit it here.

Let V_n be an n -dimensional vector space with basis $\{e_1, \dots, e_n\}$. It becomes a right M -comodule by

$$\varrho : V_n \rightarrow V_n \otimes M, e_j \mapsto \sum_{i=1}^n e_i \otimes x_{ij}. \tag{4-1}$$

The tensor algebra $T(V_n)$ is a right M -comodule algebra by the algebra map extension of $\varrho : T(V_n) \rightarrow T(V_n) \otimes M$,

$$\varrho(e_{j_1} \cdots e_{j_r}) := \sum_{i_1, \dots, i_r} e_{i_1} \cdots e_{i_r} \otimes x_{i_1, j_1} \cdots x_{i_r, j_r}. \tag{4-2}$$

The appropriate restriction of ϱ makes $V_n \otimes V_n$ into an M -comodule. (For a general survey of comodules and comodule algebras, see for example Section 4 of Montgomery’s book *Hopf algebras and their actions on rings*, CBMS Regional Conference Series in Mathematics 82, AMS, 1993.)

LEMMA 4.8 (THE R-MATRIX INDUCES A COLINEAR MAP). *The linear map $R_q : V_n \otimes V_n \rightarrow V_n \otimes V_n$ defined by $R_q \in M_n(k) \otimes M_n(k)$ is given as follows:*

$$e_i \otimes e_j \mapsto \begin{cases} e_j \otimes e_i, & \text{if } i < j, \\ qe_i \otimes e_i, & \text{if } i = j, \\ e_j \otimes e_i + (q - q^{-1})e_i \otimes e_j, & \text{if } i > j. \end{cases}$$

It is an M -comodule map.

PROOF. The $((ik), (j\ell))$ -component of $X^{(2)}$ is, by definition, $x_{ij}x_{k\ell}$. Since

$$\varrho(e_j \otimes e_\ell) = \sum_{i,k} (e_i \otimes e_k) \otimes x_{ij}x_{k\ell},$$

the relation $X^{(2)}R_q = R_qX^{(2)}$ implies the claim. □

It follows that the kernel and the image of $(R_q - qI)$ are M -subcomodules of $V_n \otimes V_n$. They are given explicitly as follows:

$$\begin{aligned} \text{Im}(R_q - qI) &= k\{e_j \otimes e_i - qe_i \otimes e_j \mid i < j\}, \\ \text{Ker}(R_q - qI) &= k\{e_i \otimes e_i, e_i \otimes e_j + qe_j \otimes e_i \mid i < j\}. \end{aligned}$$

This motivates the following definition:

DEFINITION 4.9 (DEFORMED SYMMETRIC AND EXTERIOR ALGEBRAS). Let I_S denote the ideal of the tensor algebra $T(V_n)$ generated by the image of $(R_q - qI)$, and I_\wedge the ideal generated by the kernel of $(R_q - qI)$. We call $S_q(V_n) := T(V_n)/I_S$ the q -symmetric algebra and $\wedge_q(V_n) := T(V_n)/I_\wedge$ the q -exterior algebra.

It is not difficult to show that $S_q(V_n)$ has the basis

$$\{e_1^{s_1} \cdots e_n^{s_n} \mid \text{all } s_i \geq 0\},$$

and $\wedge_q(V_n)$ has the basis

$$\{e_{i_1} \cdots e_{i_m} \mid 1 \leq i_1 < \cdots < i_m \leq n\}.$$

They are made into graded algebras by defining the degree of all e_i to be 1.

COROLLARY 4.10 (THE COACTION OF M AND THE q -DETERMINANT). (a) *The algebras $S_q(V_n)$ and $\Lambda_q(V_n)$ are right M -comodule algebras by the coaction induced by ϱ .*

(b) *There is a unique $g \in M$ such that $\varrho(e_1 \cdots e_n) = e_1 \cdots e_n \otimes g$, where $e_1 \cdots e_n \in \Lambda_q(V_n)$, namely*

$$g = \sum_{\sigma \in S_n} (-q)^{-\ell(\sigma)} x_{\sigma(1),1} \cdots x_{\sigma(n),n}$$

(where $\ell(\sigma)$ denotes the number of inversions of a permutation σ).

PROOF. The ideals I_S, I_\wedge considered in Definition 4.9 are M -subcomodules by Lemma 4.8. This implies (a).

All homogeneous components of $S_q(V_n)$ and $\Lambda_q(V_n)$ are M -subcomodules. In particular, the n -th component of $\Lambda_q(V_n)$, which is $k \cdot e_1 \cdots e_n$, is a 1-dimensional M -subcomodule. Hence, there is a group-like element $g \in M$ with the required property. Uniqueness is clear, since $e_1 \cdots e_n \neq 0$ in $\Lambda_q(V_n)$.

To calculate g , observe that in $\Lambda_q(V_n)$, we have

$$e_{\sigma(1)} \cdots e_{\sigma(n)} = (-q)^{-\ell(\sigma)} e_1 \cdots e_n,$$

for all $\sigma \in S_n$. From (4-2), we obtain the required result:

$$\begin{aligned} \varrho(e_1 \cdots e_n) &= \sum_{i_1, \dots, i_n} e_{i_1} \cdots e_{i_n} \otimes x_{i_1,1} \cdots x_{i_n,n} \\ &\stackrel{(!)}{=} \sum_{\sigma \in S_n} e_{\sigma(1)} \cdots e_{\sigma(n)} \otimes x_{\sigma(1),1} \cdots x_{\sigma(n),n} \\ &= \sum_{\sigma \in S_n} (-q)^{-\ell(\sigma)} e_1 \cdots e_n \otimes x_{\sigma(1),1} \cdots x_{\sigma(n),n} \end{aligned}$$

(for “(!)”, notice that $e_{i_1} \cdots e_{i_r} = 0$ in $\Lambda_q(V_n)$, if $i_j = i_\ell$ for some $j \neq \ell$). \square

DEFINITION 4.11 (THE QUANTUM DETERMINANT). The element $g \in M$ is called the q -determinant (or quantum determinant) of X and denoted by $|X|_q$.

Note that for $n = 2$, we obtain the q -determinant as defined in Section 1 (see Definition 1.1).

DEFINITION 4.12 (THE QUANTUM ADJOINT MATRIX). Let X_{ij} denote the $(n-1) \times (n-1)$ minor of X , obtained by removing the i -th row and the j -th column. Note that X_{ij} is again a q -matrix. The q -adjoint matrix of X is defined as

$$\tilde{X} := ((-q)^{j-i} |X_{ji}|_q)_{i,j}.$$

PROPOSITION 4.13 (QUANTUM ADJOINT MATRIX, QUANTUM DETERMINANT). *We have*

$$X\tilde{X} = \tilde{X}X = |X|_q I.$$

PROOF. Writing $\widehat{e}_i := e_1 \cdots e_{i-1} e_{i+1} \cdots e_n \in \bigwedge_q(V_n)$, it is easily checked that

$$\varrho(\widehat{e}_j) = \sum_{i=1}^n \widehat{e}_i \otimes |X_{ij}|_q. \tag{4-3}$$

It follows from the relations in $\bigwedge_q(V_n)$ that

$$\widehat{e}_i e_j = \delta_{ij} (-q)^{i-n} e_1 \cdots e_n. \tag{4-4}$$

The last two equations imply

$$\begin{aligned} \delta_{jk} (-q)^{j-n} e_1 \cdots e_n \otimes g &\stackrel{(4-4)}{=} \varrho(\widehat{e}_j e_k) \stackrel{(4-3)}{=} \sum_{i=1}^n \widehat{e}_i e_i \otimes |X_{ij}|_q x_{ik} \\ &\stackrel{(4-4)}{=} \sum_{i=1}^n e_1 \cdots e_n \otimes (-q)^{i-n} |X_{ij}|_q x_{ik}. \end{aligned}$$

Comparison of the coefficients of $e_1 \cdots e_n$ yields

$$\delta_{jk} (-q)^{j-n} g = \sum_i (-q)^{i-n} |X_{ij}|_q x_{ik},$$

which means that $gI = \widetilde{X}X$. Similarly, one sees $gI = X\widetilde{X}$ by using the fact that $|X|_q = |X^t|_q$. □

Since $gX = X\widetilde{X}X = Xg$, we get:

COROLLARY 4.14. *The quantum determinant $|X|_q$ is central in M .*

THEOREM 4.15 (THE QUANTIZED GENERAL LINEAR GROUP). *Suppose that $M := \mathcal{O}_q(M(n))$ and let $H := M[g^{-1}]$. Then H is a Hopf algebra.*

PROOF. We denote the images in H of the generators $x_{ij} \in M$ again by x_{ij} .

By Proposition 4.13, the matrix X is invertible in $M_n(H)$, with inverse

$$X^{-1} = g^{-1} \widetilde{X} = \widetilde{X} g^{-1}.$$

In the opposite algebra H^{op} of H , we have

$$(X^{-1})^{(2)} = ((X^{-1})_{k\ell} (X^{-1})_{ij})_{(ik),(j\ell)} = (X^{(2)})^{-1}.$$

This matrix commutes with R_q , since so does $X^{(2)}$ (cf. Proposition 4.3). This shows that X^{-1} is a q -matrix with entries in H^{op} .

Hence, there is an algebra map S' , defined by

$$S' : M \rightarrow H^{\text{op}}, \quad X \mapsto X^{-1} \text{ (componentwise).}$$

This induces an anti-algebra map $S : M \rightarrow H$.

We show that S factors through H . Let $C : M \rightarrow H$ denote the canonical map $(x_{ij} \mapsto x_{ij})$. It is easy to check that the relation

$$S * C = u\varepsilon = C * S \tag{4-5}$$

holds on the generators x_{ij} . (Here “ $*$ ” denotes the convolution product and u , resp. ε the unit of H , resp. the counit of M .)

It is not difficult to deduce that (4–5) holds (everywhere). We apply (4–5) to g and obtain, since g is group-like:

$$S(g)g = 1 = gS(g).$$

Hence, $S(g) = g^{-1}$, and we can extend S to an anti-algebra map

$$S : H \rightarrow H, \quad g \mapsto g^{-1}, \quad g^{-1} \mapsto g.$$

This is the antipode of H (it suffices to verify the axiom for the antipode on generators, which is easily done). □

DEFINITION 4.16. The *category of quantum groups* is, by definition, the opposite category of the category of Hopf algebras. The Hopf algebra associated to the quantum group G is denoted by $\mathcal{O}(G)$.

DEFINITION 4.17. We write

$$\mathcal{O}_q(\mathrm{GL}(n)) := H, \quad \mathcal{O}_q(\mathrm{SL}(n)) := H/(g - 1).$$

The associated quantum groups $\mathrm{GL}_q(n)$ and $\mathrm{SL}_q(n)$ are called the *quantized general* and *special linear groups*.

5. A q -Analogue of the Cayley–Hamilton Theorem

This section discusses a quantized version of the Cayley–Hamilton theorem, found by J. Zhang (1991). We start with a few notations:

DEFINITION 5.1. Let $A = (a_{ij})$ be an $(n \times n)$ q -matrix with entries in some k -algebra. We use the abbreviation

$$q_{ij} := \begin{cases} q & \text{for } i < j, \\ 1 & \text{for } i = j, \\ q^{-1} & \text{for } i > j. \end{cases}$$

For elements $i_1 < \dots < i_m$ and $j_1 < \dots < j_m$ of $[1, n] := \{1, 2, \dots, n\}$, we write

$$D(i_1, \dots, i_m \mid j_1, \dots, j_m) := |A_{\{i_1, \dots, i_m\}\{j_1, \dots, j_m\}}|_q, \tag{5-1}$$

and define, for $j, m \in [1, n]$:

$$\begin{aligned} tr_j^m &:= \sum_{1 \leq i_1 < \dots < i_m \leq n} q_{i_1, j} \cdots q_{i_m, j} D(i_1, \dots, i_m \mid i_1, \dots, i_m), \\ \mathrm{Tr}^m &:= \begin{pmatrix} tr_1^m & & 0 \\ & \ddots & \\ 0 & & tr_n^m \end{pmatrix}. \end{aligned}$$

In particular, $tr_j^1 = \sum_{i=1}^n q_{ij} a_{ii}$ and $tr_j^n = q_{1j} \cdots q_{nj} |A|_q$.

THEOREM 5.2 (THE q -CAYLEY–HAMILTON THEOREM). *For any q -matrix A , we have:*

$$A^n - \text{Tr}^1 A^{n-1} + \cdots + (-1)^{n-1} \text{Tr}^{n-1} A + (-1)^n \text{Tr}^n = 0.$$

PROOF. (1) Take any $i_1, \dots, i_m, j_1, \dots, j_m \in [1, n]$. Writing $i := (i_1, \dots, i_m)$, $j := (j_1, \dots, j_m)$, and $i\sigma := (i_{\sigma(1)}, \dots, i_{\sigma(m)})$ (for a permutation $\sigma \in S_m$), we put (in accordance with (5-1), if $i_1 < \cdots < i_m$ and $j_1 < \cdots < j_m$):

$$D(i | j) := \sum_{\sigma \in S_m} (-q)^{\ell(i) - \ell(i\sigma)} a_{i_{\sigma(1)}, j_1} \cdots a_{i_{\sigma(m)}, j_m},$$

and this term vanishes, unless i_1, \dots, i_m are distinct and j_1, \dots, j_m are distinct. (Here $\ell(i)$ denotes the number of inversions in (i_1, \dots, i_m) .)

(2) When i_1, \dots, i_m are distinct and j_1, \dots, j_m are distinct, put $\{i'_1, \dots, i'_m\} := \{i_1, \dots, i_m\}$, such that $i'_1 < \cdots < i'_m$, and define $j'_1 < \cdots < j'_m$ similarly. Writing $i' := (i'_1, \dots, i'_m)$ and $j' := (j'_1, \dots, j'_m)$, we obtain:

$$D(i | j) = (-q)^{\ell(i) - \ell(j)} D(i' | j'). \tag{5-2}$$

For any $k \in [1, m]$, we write

$$S_m^k := \{\sigma \in S_m \mid \sigma(1) < \cdots < \sigma(k) \text{ and } \sigma(k+1) < \cdots < \sigma(m)\}.$$

Then the following Laplace expansion formula can be shown (for all $1 \leq k \leq m$):

$$D(i | j) = \sum_{\sigma \in S_m^k} (-q)^{\ell(i) - \ell(i\sigma)} D(i_{\sigma(1)}, \dots, i_{\sigma(k)} | j_1, \dots, j_k) \cdot D(i_{\sigma(k+1)}, \dots, i_{\sigma(m)} | j_{k+1}, \dots, j_m).$$

For $(m+1, m)$ instead of (m, k) , we obtain, in particular, for all $i_0, j_0 \in [1, n]$:

$$\begin{aligned} D(i_0, i | i, j_0) &= (-q)^{\ell(i_0, i) - \ell(i, i_0)} D(i | i) a_{i_0, j_0} \\ &\quad + \sum_{t=1}^m (-q)^{\ell(i_0, i) - \ell(i_0, \dots, \widehat{i}_t, \dots, i_m, i_t)} D(i_0, \dots, \widehat{i}_t, \dots, i_m | i) a_{i_t, j_0} \\ &= (-q_{i_1, i_0}) \cdots (-q_{i_m, i_0}) D(i | i) a_{i_0, j_0} \\ &\quad + \sum_{t=1}^m D(i_0, \dots, \widehat{i}_t, \dots, i_m | i_1, \dots, \widehat{i}_t, \dots, i_m, i_t) a_{i_t, j_0}. \end{aligned} \tag{5-3}$$

(3) For any $i, j \in [1, n]$, we write

$$\begin{aligned} b_{ij}^m &:= \sum_{1 \leq i_1 < \cdots < i_m \leq n} D(i, i_1, \dots, i_m | i_1, \dots, i_m, j), \\ B^m &:= (b_{ij}^m)_{i, j}. \end{aligned}$$

It follows from (5-3) that

$$B^m = (-1)^m \text{Tr}^m A + B^{m-1} A$$

for all $1 \leq m \leq n - 1$, where $B^0 = A$. It follows immediately, by induction, that

$$B^m = (-1)^m \text{Tr}^m A + (-1)^{m-1} \text{Tr}^{m-1} A^2 + \dots + (-1) \text{Tr}^1 A^m + A^{m+1},$$

hence

$$B^{n-1} = (-1)^{n-1} \text{Tr}^{n-1} A + (-1)^{n-2} \text{Tr}^{n-2} A^2 + \dots + (-1) \text{Tr}^1 A^{n-1} + A^n.$$

It remains to verify that $B^{n-1} = (-1)^{n-1} \text{Tr}^n$.

Because of step (1), we have

$$b_{ij}^{n-1} = \sum_{1 \leq i_1 < \dots < i_{n-1} \leq n} D(i, i_1, \dots, i_{n-1} \mid i_1, \dots, i_{n-1}, j) = 0,$$

unless $i = j$. If $i = j$, however, we get:

$$\begin{aligned} b_{ii}^{n-1} &= D(i, 1, \dots, \hat{i}, \dots, n \mid 1, \dots, \hat{i}, \dots, n, i) \\ &\stackrel{(5-2)}{=} (-q)^{\ell(i, 1, \dots, \hat{i}, \dots, n) - \ell(1, \dots, \hat{i}, \dots, n, i)} |A|_q \\ &= (-1)^{n-1} (q_{1i} \cdot \dots \cdot q_{ni}) |A|_q \\ &= (-1)^{n-1} \text{tr}_i^n, \end{aligned}$$

where we have used that $\ell(i, 1, \dots, \hat{i}, \dots, n) = i - 1$ and $\ell(1, \dots, \hat{i}, \dots, n, i) = n - i$. Hence, $B^{n-1} = (-1)^{n-1} \text{Tr}^n$. \square

6. The R -Matrix R_q and the Homfly Polynomial

The Homfly polynomial can be associated to every oriented link diagram and is invariant under regular isotopy. The name comes from the initials of Hoste, Ocneanu, Millett, Freyd, Lickorish and Yetter.

In this section, we use the following abbreviations for parts of oriented link diagrams:

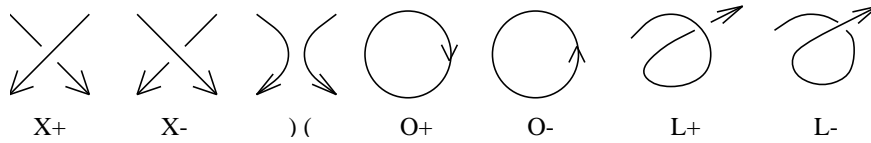

Figure 6. Types of crossings and loops

DEFINITION 6.1 (THE HOMFLY POLYNOMIAL). Let K be an oriented link diagram. The *Homfly polynomial* of K , denoted by $H_K(\alpha, z) \in \mathbb{Z}[\alpha, \alpha^{-1}, z, z^{-1}]$ is characterized by the following properties:

- (a) If K is regularly isotopic to K' (denoted as $K \approx K'$), then $H_K = H_{K'}$;
- (b) $H_{O+} = 1$;
- (c) $H_{X+} - H_{X-} = zH_{)(}$;
- (d) $H_{L+} = \alpha H_{\rightarrow}, H_{L-} = \alpha^{-1} H_{\rightarrow}$.

Using these rules, one can calculate H_K , using so-called *skein trees*. We illustrate this procedure with the trefoil.

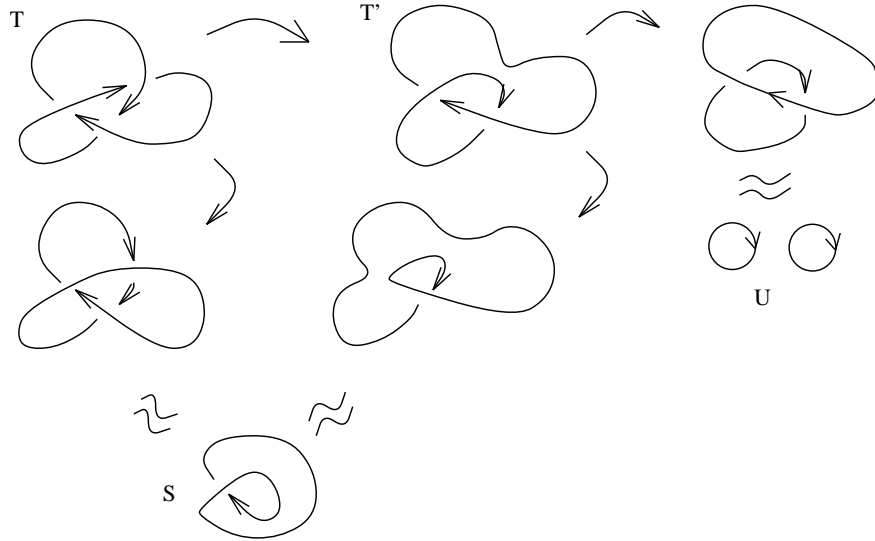

Figure 7. A skein tree for the trefoil

Using (c), (d) of Definition 6.1, it is an easy exercise to show that, for any K :

$$H_{O+K} = \delta H_K,$$

with $\delta := (\alpha - \alpha^{-1})z^{-1}$. Hence, in particular, $H_U = H_{O+O} = \delta$.

Now we can calculate the Homfly polynomial of the trefoil T as follows:

$$\begin{aligned} H_T &\stackrel{(c)}{=} H_S + zH_{T'} \stackrel{(c)}{=} H_S + z(zH_S + H_U) \\ &= \alpha + z^2\alpha + z\delta = 2\alpha - \alpha^{-1} + z^2\alpha. \end{aligned}$$

In general, many skein trees derive from a given K . But the computation always yields the same polynomial H_K , which is, hence, well-defined.

We prove this using the R -matrix R_q introduced in Definition 4.2.

Let q be an indeterminate and R_q have size $(n + 1)^2 \times (n + 1)^2$. Recall that

$$R_q = q \sum_i \mathbb{E}_{ii} \otimes \mathbb{E}_{ii} + \sum_{i \neq j} \mathbb{E}_{ij} \otimes \mathbb{E}_{ji} + (q - q^{-1}) \sum_{i < j} \mathbb{E}_{jj} \otimes \mathbb{E}_{ii}.$$

Here, we let i, j range over the set of indices $\mathcal{J} := \{-n, -n + 2, \dots, n - 2, n\}$.

We associate R_q (resp. R_q^{-1}) to crossings X^+ (positive crossing), resp. X^- (negative crossing).

We write

$$\begin{aligned} \mathbb{E}_{jj} \otimes \mathbb{E}_{ii} &=: \langle j \rangle \langle i \rangle, \\ \mathbb{E}_{ij} \otimes \mathbb{E}_{ji} &=: \langle i \searrow \swarrow j \rangle. \end{aligned}$$

Thus the summands of R_q have the following form (we omit the summation sign in our symbolic notation)

$$\begin{aligned} \sum_{j>i} \mathbb{E}_{jj} \otimes \mathbb{E}_{ii} &= \langle \rangle^{\rangle} \langle \rangle, \\ \sum_i \mathbb{E}_{ii} \otimes \mathbb{E}_{ii} &= \langle \rangle^= \langle \rangle, \\ \sum_{i \neq j} \mathbb{E}_{ij} \otimes \mathbb{E}_{ji} &= \langle \not\searrow \not\swarrow \rangle. \end{aligned}$$

We aim to show that these identifications are compatible with the defining equations of the Homfly polynomial. Firstly observe that

$$\begin{aligned} R_q &= \langle X^+ \rangle = (q - q^{-1}) \langle \rangle^{\rangle} \langle \rangle + q \langle \rangle^= \langle \rangle + \langle \not\searrow \not\swarrow \rangle, \\ R_q^{-1} &= \langle X^- \rangle = (q^{-1} - q) \langle \rangle^{\langle} \langle \rangle + q^{-1} \langle \rangle^= \langle \rangle + \langle \not\swarrow \not\searrow \rangle, \end{aligned}$$

since

$$R_q^{-1} = q^{-1} \sum_i \mathbb{E}_{ii} \otimes \mathbb{E}_{ii} + \sum_{i \neq j} \mathbb{E}_{ij} \otimes \mathbb{E}_{ji} + (q^{-1} - q) \sum_{i < j} \mathbb{E}_{ii} \otimes \mathbb{E}_{jj}.$$

The coefficients $(q - q^{-1})$, q , $(q^{-1} - q)$, q^{-1} , 1 are called *vertex weights*.

REMARK 6.2. For $z := q - q^{-1}$, the equation in Definition 6.1 (c) is satisfied:

$$\begin{aligned} \langle X^+ \rangle - \langle X^- \rangle &= (q - q^{-1}) (\langle \rangle^{\rangle} \langle \rangle + \langle \rangle^{\langle} \langle \rangle + \langle \rangle^= \langle \rangle) \\ &= (q - q^{-1}) \langle \rangle \langle \rangle. \end{aligned}$$

We apply the following procedures (S1) and (S2) to a given oriented link diagram K .

(S1) Replace each crossing X^+ , X^- in K by $\not\searrow \not\swarrow$ or $\not\swarrow \not\searrow$.

For the trefoil, there are three possible results shown in Figure 8.

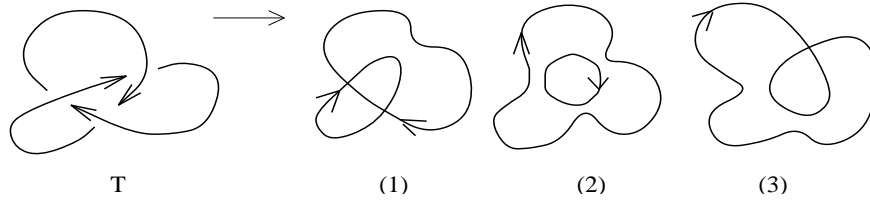

Figure 8. Procedure (S1) applied to the trefoil

From this step, we obtain oriented *link shadows*. We only admit link shadows that have no self-intersection. In Figure 8, this still allows (1) and (2), but rules out (3).

Let σ be any admissible link shadow obtained from K by (S1).

(S2) Label an element of \mathcal{J} (called *spin*) to each component of σ , such that

- a) Two components of the same spin do not intersect;
- b) If ${}_a)_b$ in σ comes from X^+ (resp. X^-) in K , then $a \geq b$ (resp. $a \leq b$).

In the example above, we must have $a > b$ for ${}_a)_b$ in shadow (1) and $a \geq b$ for ${}_a)_b$ in shadow (2).

DEFINITION 6.3 (STATES OF A LINK DIAGRAM). A *state* of a link diagram is an admissible link shadow, with spins labelled to its components according to (S2).

The trefoil has three kinds of states of type (1) and states of type (2).

DEFINITION 6.4. Let σ be a state of K . Let $\langle K | \sigma \rangle$ be the product of vertex weights of σ at the crossings of K , i.e. the product of the following values:

$$\begin{aligned} \langle X^+ | \langle \rangle^{\rangle} \rangle &= q - q^{-1}, & \langle X^- | \langle \rangle^{\langle} \rangle &= q^{-1} - q, \\ \langle X^+ | \langle \rangle^{\text{=}} \rangle &= q, & \langle X^- | \langle \rangle^{\text{=}} \rangle &= q^{-1}, \\ \langle X^+ | \langle \rangle^{\neq} \rangle &= 1, & \langle X^- | \langle \rangle^{\neq} \rangle &= 1 \end{aligned}$$

(the left hand side symbols the type of the crossing in K , the right hand side indicates the relation between the spins in σ).

Note that conditions (a) and (b) in (S2) imply that always (precisely) one of the cases in Definition 6.4 holds.

In the example of the trefoil, we obtain (cf. Figure 8):

$$\begin{aligned} \langle T | \sigma_{(1)} \rangle &= q - q^{-1}, \text{ since } a > b, \\ \langle T | \sigma_{(2)} \rangle &= \begin{cases} (q - q^{-1})^3, & \text{if } a > b, \\ q^3, & \text{if } a = b. \end{cases} \end{aligned}$$

DEFINITION 6.5. For a state σ of an oriented link diagram K , define

$$\|\sigma\| := \sum (\text{not}(\ell)\text{label}(\ell) \mid \ell \text{ is a component of } \sigma),$$

where $\text{not}(O^+) := 1$, $\text{not}(O^-) := -1$, and $\text{label}(\ell) \in \mathcal{J}$ denotes the spin labelled to ℓ .

DEFINITION 6.6 (THE KAUFFMAN POLYNOMIAL). For an oriented link diagram K , define *Kauffman's polynomial* $\langle K \rangle$ as

$$\langle K \rangle := \sum (\langle K | \sigma \rangle q^{\|\sigma\|} \mid \sigma \text{ is a state of } K),$$

which is a polynomial in $\mathbb{Z}[q, q^{-1}]$, depending on n .

REMARK 6.7. The polynomial associated to the circle can be calculated as follows:

$$\begin{aligned} \langle O^+ \rangle &= \sum_{a \in \mathcal{J}} \underbrace{\langle O^+ | O^{+a} \rangle}_{=1} q^{\|O^{+a}\|} = \sum_{a \in \mathcal{J}} q^a \\ &= \frac{q^{n+1} - q^{-n-1}}{q - q^{-1}} = \delta, \end{aligned}$$

if one puts $\alpha := q^{n+1}$ (and δ and z as before; cf. the beginning of this section and Remark 6.2).

Let K denote any oriented link diagram containing a part of the form L^+ (cf. Figure 6). By (S1) and (S2), any part of K of the form L^+ is transformed into a state of the form

$$\sigma(a, b) := \overrightarrow{O^+}_{+b}, \quad \text{where } a \leq b.$$

Let $\langle L^+ \rangle$ denote the polynomial associated to K and let $\langle \rightarrow \rangle$ denote the polynomial of the diagram obtained from K by replacing one occurrence of L^+ by “ \rightarrow ”. Then we get

$$\begin{aligned} \langle L^+ | \sigma(a, b) \rangle &= \langle \rightarrow | \rightarrow^a \rangle \cdot \begin{cases} q & \text{if } a = b, \\ q - q^{-1} & \text{if } a < b, \end{cases} \\ \|\sigma(a, b)\| &= b + \|\rightarrow^a\|, \end{aligned}$$

which implies

$$\begin{aligned} \langle L^+ \rangle &= \sum_{a \leq b} \langle L^+ | \sigma(a, b) \rangle q^{\|\sigma(a, b)\|} \\ &= \sum_a \underbrace{\left(qq^a + \sum_{b>a} (q - q^{-1})q^b \right)}_{=q^{n+1}} \langle \rightarrow | \rightarrow^a \rangle q^{\|\rightarrow^a\|} \\ &= q^{n+1} \sum_a \langle \rightarrow | \rightarrow^a \rangle q^{\|\rightarrow^a\|} = q^{n+1} \langle \rightarrow \rangle. \end{aligned}$$

REMARK 6.8. This coincides with Definition 6.1 (d), for $\alpha = q^{n+1}$ (as above). Similarly, one sees the analogue relation for $\langle L^- \rangle$.

THEOREM 6.9 (Kauffman). *The polynomial $\langle K \rangle$ is invariant under regular isotopy and satisfies*

$$\langle O^+ \rangle = \delta = \frac{q^{n+1} - q^{-n-1}}{q - q^{-1}}, \quad (6-1)$$

$$\langle X^+ \rangle - \langle X^- \rangle = (q - q^{-1}) \langle \rangle \langle \rangle, \quad (6-2)$$

$$\langle L^+ \rangle = q^{n+1} \langle \rightarrow \rangle, \quad (6-3)$$

$$\langle L^- \rangle = q^{-n-1} \langle \rightarrow \rangle. \quad (6-4)$$

PROOF. We have shown Equations (6-1)–(6-1) in Remarks 6.7, 6.2 and 6.8.

We leave it to the reader to verify that $\langle K \rangle$ is invariant under Reidemeister moves (II) and (III) for oriented diagrams (Figure 2). This gives invariance under regular isotopy. \square

COROLLARY 6.10. *Kauffman's polynomial and the Homfly polynomial satisfy*

$$\langle K \rangle = \langle O^+ \rangle H_K(q^{n+1}, q - q^{-1}).$$

Since the map $\mathbb{Z}[\alpha, \alpha^{-1}, z, z^{-1}] \rightarrow \mathbb{Q}(q)$ defined by $\alpha \mapsto q^{n+1}$, $z \mapsto q - q^{-1}$ is injective, the Homfly polynomial is well-defined.

It is an easy exercise to verify that Kauffman's polynomial of the trefoil T is indeed

$$\langle T \rangle = ((q^2 + q^{-2})q^{n+1} - q^{-n-1})\delta = H_T(q^{n+1}, q - q^{-1})\delta.$$

7. Duality with the Quantized Enveloping Algebra $U_q(\mathfrak{sl}_n)$

In this section, we examine the duality of the Hopf algebra $\mathcal{O}_q(\mathrm{SL}(n))$ and the quantized enveloping algebra of the Lie algebra \mathfrak{sl}_n .

DEFINITION 7.1 (THE QUANTIZED ENVELOPING ALGEBRA OF \mathfrak{sl}_2). For $q^2 \neq 1$, the algebra $U_q(\mathfrak{sl}_2)$ is generated by elements K, K^{-1}, E, F , subject to the following relations:

$$\begin{aligned} KK^{-1} &= K^{-1}K = 1, \\ KEK^{-1} &= q^2E, \\ KFK^{-1} &= q^{-2}F, \\ EF - FE &= \frac{K - K^{-1}}{q - q^{-1}}. \end{aligned}$$

PROPOSITION 7.2. *The algebra $U_q(\mathfrak{sl}_2)$ has a basis $\{F^i K^s E^j \mid i, j \geq 0, s \in \mathbb{Z}\}$.*

It carries a Hopf algebra structure as follows:

$$\begin{aligned} \Delta(K) &= K \otimes K, & \varepsilon(K) &= 1, & S(K) &= K^{-1}, \\ \Delta(E) &= 1 \otimes E + E \otimes K, & \varepsilon(E) &= 0, & S(E) &= -EK^{-1}, \\ \Delta(F) &= K^{-1} \otimes F + F \otimes 1, & \varepsilon(F) &= 0, & S(F) &= -KF. \end{aligned}$$

The proof is not easy and involves tedious computations. We omit it here (see Section 15).

We examine the relationship of the dual Hopf algebra $U_q(\mathfrak{sl}_2)^\circ$ with $\mathcal{O}_q(\mathrm{GL}(n))$. Recall the definition of the dual of a Hopf algebra:

DEFINITION 7.3. Let H be a Hopf algebra. Let $\pi : H \rightarrow M_n(k)$ be a finite dimensional representation of H and $\pi^* : (M_n(k))^* \rightarrow H^*$ be the dual map. The dual of H is defined as

$$H^\circ := \sum (\mathrm{Im}(\pi^*) \mid \pi : H \rightarrow M_n(k), \text{ as above, } n \geq 1).$$

DEFINITION 7.4 (TENSOR PRODUCTS AND TRANSPOSES OF REPRESENTATIONS). Let $\pi : H \rightarrow M_n(k)$ and $\pi' : H \rightarrow M_m(k)$ be representations of a Hopf algebra H .

(a) The tensor product $\pi \otimes \pi'$ is defined as the representation

$$H \xrightarrow{\Delta} H \otimes H \xrightarrow{\pi \otimes \pi'} M_n(k) \otimes M_m(k) \xrightarrow{\cong} M_{nm}(k).$$

(b) The transpose π^t is defined as the representation

$$H \xrightarrow{S} H \xrightarrow{\pi} M_n(k) \xrightarrow{\text{transpose}} M_n(k).$$

This definition implies that

$$\text{Im}((\pi \otimes \pi')^*) = \text{Im}(\pi^*)\text{Im}(\pi'^*), \quad \text{Im}((\pi^t)^*) = S^*(\text{Im}(\pi^t)).$$

Using the tensor product and the transpose of representations, one can show, successively:

- PROPOSITION 7.5. (a) *There is precisely one coalgebra structure on H° , such that π^* is a coalgebra map, for all finite dimensional representations π of H .*
 (b) *H° is a subalgebra of H^* (with the convolution product).*
 (c) *H° is S^* invariant.*
 (d) *H° is a Hopf algebra with antipode S^* .*
 (e) *Assume all finite dimensional representations of H are completely reducible. Let $\{\pi_\lambda \mid \lambda \in \Lambda\}$ be a complete set of (pairwise non-isomorphic) finite dimensional representations of H . Then*

$$H^\circ = \bigoplus_{\lambda \in \Lambda} \text{Im}(\pi_\lambda^*)$$

(cf. the Peter–Weyl theorem in the theory of Lie groups).

We assume q is not a root of unity and $\text{char}(k) \neq 2$ up to 7.11.

THEOREM 7.6 (REPRESENTATIONS OF $U_q(\mathfrak{sl}_2)$) (Rosso). (a) *All finite dimensional representations of $U_q(\mathfrak{sl}_2)$ are completely reducible.*

(b) *all finite dimensional irreducible representations of $U_q(\mathfrak{sl}_2)$ are exhausted by*

$$\pi_n : U_q(\mathfrak{sl}_2) \rightarrow M_{n+1}(k), \pi'_n : U_q(\mathfrak{sl}_2) \rightarrow M_{n+1}(k),$$

which are defined as follows:

$$\begin{aligned} \pi_n(K) &:= \begin{pmatrix} q^n & & & 0 \\ & q^{n-2} & & \\ & & \ddots & \\ 0 & & & q^{-n} \end{pmatrix}, \\ [6pt]\pi_n(E) &:= \begin{pmatrix} 0 & [n] & & 0 \\ & \ddots & \ddots & \\ & & \ddots & [1] \\ 0 & & & 0 \end{pmatrix}, \pi_n(F) := \begin{pmatrix} 0 & & & 0 \\ [1] & \ddots & \ddots & \\ 0 & \ddots & \ddots & [n] \\ & & & 0 \end{pmatrix}, \\ [6pt]\pi'_n(K) &:= -\pi_n(K), \pi'_n(E) := \pi_n(E), \pi'_n(F) := -\pi_n(F), \\ \text{where } [i] &:= \frac{q^i - q^{-i}}{q - q^{-1}}. \end{aligned}$$

COROLLARY 7.7 (THE DUAL OF $U_q(\mathfrak{sl}_2)$). *The dual Hopf algebra of $U_q(\mathfrak{sl}_2)$ is*

$$U_q(\mathfrak{sl}_2)^\circ = \bigoplus_{n=0}^{\infty} (\text{Im}(\pi_n^*) \oplus \text{Im}((\pi'_n)^*)).$$

PROPOSITION 7.8. *The following equivalences hold for representations of $U_q(\mathfrak{sl}_2)$:*

- (a) $\pi'_n \cong \pi_n \otimes \pi'_0 \cong \pi'_0 \otimes \pi_n$;
- (b) $\pi'_n \cong \pi_n$;
- (c) (CLEBSCH–GORDAN RULE) $\pi_m \otimes \pi_n \cong \pi_{m+n} \oplus \pi_{m+n-2} \oplus \dots \oplus \pi_{|m-n|}$.

In particular, $\pi'_0 : U_q(\mathfrak{sl}_2) \rightarrow k, K \mapsto -1, E, F \mapsto 0$ defines an algebra map and, hence, corresponds to a group-like element $\gamma \in U_q(\mathfrak{sl}_2)^\circ$. This element γ has order 2.

It follows from Proposition 7.8 (a) that

$$\text{Im}(\pi_n'^*) = \gamma \text{Im}(\pi_n^*) = \text{Im}(\pi_n^*)\gamma.$$

Hence, the following sub-coalgebra is normalized by γ :

$$A := \bigoplus_{n=0}^{\infty} \text{Im}(\pi_n^*).$$

Because of (b), A is S^* -invariant. For the case $n = 1$, we have

$$\pi_1^t = \text{inn} \left(\begin{matrix} & -1 \\ q & \end{matrix} \right) \circ \pi_1, \tag{7-1}$$

which is easily checked on the generators of $U_q(\mathfrak{sl}_2)$. (Here, $\text{inn}(P)$ denotes the inner automorphism induced by an invertible matrix P , that is, $\text{inn}(P) : M_n(k) \rightarrow M_n(k), Y \mapsto PYP^{-1}$.)

The Clebsch–Gordan rule implies that A is a subalgebra (hence a Hopf subalgebra), which is generated, as algebra, by $\text{Im}(\pi_1^*)$.

THEOREM 7.9 ($\mathcal{O}_q(\text{SL}(2))$ AS A HOPF SUBALGEBRA OF $U_q(\mathfrak{sl}_2)^\circ$). *Let $\pi_1 : U_q(\mathfrak{sl}_2) \rightarrow M_2(k)$ and $A \subset U_q(\mathfrak{sl}_2)$ be as above and define $a, b, c, d \in U_q(\mathfrak{sl}_2)^\circ$ by*

$$\begin{pmatrix} a(x) & b(x) \\ c(x) & d(x) \end{pmatrix} := \pi_1(x) \quad \text{for all } x \in U_q(\mathfrak{sl}_2).$$

Then there is a unique isomorphism of Hopf algebras, given by

$$\varphi : \mathcal{O}_q(\text{SL}(2)) \rightarrow A, \quad X \mapsto \begin{pmatrix} a & b \\ c & d \end{pmatrix}.$$

PROOF. We only prove that φ is a well-defined, surjective Hopf algebra map (injectivity can be shown by tedious computational arguments, for which we refer to the references).

By definition, (a, b, c, d) is a basis of $\text{Im}(\pi_1^*)$. Since π_1^* is a coalgebra map, it follows that

$$\begin{pmatrix} \Delta(a) & \Delta(b) \\ \Delta(c) & \Delta(d) \end{pmatrix} = \begin{pmatrix} a \otimes 1 & b \otimes 1 \\ c \otimes 1 & d \otimes 1 \end{pmatrix} \begin{pmatrix} 1 \otimes a & 1 \otimes b \\ 1 \otimes c & 1 \otimes d \end{pmatrix}. \tag{7-2}$$

From the definition of transposed representations, we get for all $x \in U_q(\mathfrak{sl}_2)$:

$$\pi_1^t(x) = \begin{pmatrix} a(S(x)) & b(S(x)) \\ c(S(x)) & d(S(x)) \end{pmatrix}^t = \begin{pmatrix} S(a) & S(c) \\ S(b) & S(d) \end{pmatrix} (x).$$

From (7-1), it follows that

$$\begin{pmatrix} S(a) & S(c) \\ S(b) & S(d) \end{pmatrix} = \begin{pmatrix} & -1 \\ q & \end{pmatrix} \begin{pmatrix} a & b \\ c & d \end{pmatrix} \begin{pmatrix} & q^{-1} \\ -1 & \end{pmatrix}.$$

Now we obtain, using the transpose of this equation at “(!)”, that

$$\begin{aligned} \begin{pmatrix} a & b \\ c & d \end{pmatrix}^{-1} &= \begin{pmatrix} S(a) & S(b) \\ S(c) & S(d) \end{pmatrix} \stackrel{(!)}{=} \begin{pmatrix} q^{-1} & -1 \\ & \end{pmatrix} \begin{pmatrix} a & c \\ b & d \end{pmatrix} \begin{pmatrix} -1 & q \\ & \end{pmatrix} \\ &= \begin{pmatrix} -1 & q \\ & \end{pmatrix} \begin{pmatrix} a & c \\ b & d \end{pmatrix} \begin{pmatrix} q^{-1} & -1 \\ & \end{pmatrix} = \widetilde{\begin{pmatrix} a & b \\ c & d \end{pmatrix}} \end{aligned}$$

(cf. Definition 1.2). It follows from Proposition 1.3 that $\begin{pmatrix} a & b \\ c & d \end{pmatrix}$ is a q -matrix with q -determinant 1. Hence, φ is a (well-defined) algebra map.

It follows from (7-2) that φ respects the comultiplication as well and is, hence, a Hopf algebra map (any bialgebra map between Hopf algebras automatically respects the antipode).

As shown before, (a, b, c, d) is a basis of $\text{Im}(\pi_1^*)$, which generates A as an algebra. Therefore, φ is surjective. \square

In the following, we identify $\mathcal{O}_q(\text{SL}(2))$ with the Hopf subalgebra A of $U_q(\mathfrak{sl}_2)^\circ$.

The conjugation with γ on A can be computed as

$$\gamma \begin{pmatrix} a & b \\ c & d \end{pmatrix} \gamma^{-1} = \begin{pmatrix} a & -b \\ -c & d \end{pmatrix}. \quad (7-3)$$

COROLLARY 7.10 (THE HOPF ALGEBRA STRUCTURE OF $U_q(\mathfrak{sl}_2)^\circ$). *If q is not a root of unity and $\text{char}(k) \neq 2$, the dual of $U_q(\mathfrak{sl}_2)$ can be considered as semi-direct product*

$$U_q(\mathfrak{sl}_2)^\circ = \mathcal{O}_q(\text{SL}(2)) \rtimes \mathbb{Z}_2$$

with respect to the action of $\gamma \in \mathbb{Z}_2$ on $\mathcal{O}_q(\text{SL}(2))$ given in (7-3).

These results may be generalized to $\mathcal{O}_q(\text{SL}(n))$.

DEFINITION 7.11 (THE ALGEBRA $U_q(\mathfrak{sl}_n)$). For $q^2 \neq 1$, the algebra $U_q(\mathfrak{sl}_n)$ is generated by elements K_i, K_i^{-1}, E_i, F_i , ($i \in \{1, \dots, n-1\}$), subject to the following relations:

$$\begin{aligned} K_i K_i^{-1} &= K_i^{-1} K_i = 1, \\ K_i K_j &= K_j K_i, \\ K_i E_j K_i^{-1} &= q^{\alpha_{ij}} E_j, \\ K_i F_j K_i^{-1} &= q^{-\alpha_{ij}} F_j, \\ E_i F_j - F_j E_i &= \delta_{ij} \frac{K_i - K_i^{-1}}{q - q^{-1}}, \\ E_i E_j &= E_j E_i, \quad \text{if } |i - j| \geq 2, \\ F_i F_j &= F_j F_i, \quad \text{if } |i - j| \geq 2, \\ E_i^2 E_j - (q + q^{-1}) E_i E_j E_i + E_j E_i^2 &= 0, \quad \text{if } |i - j| = 1, \\ F_i^2 F_j - (q + q^{-1}) F_i F_j F_i + F_j F_i^2 &= 0, \quad \text{if } |i - j| = 1. \end{aligned}$$

Here, $\alpha = (\alpha_{ij})_{i,j}$ denotes the Cartan matrix of the Lie algebra \mathfrak{sl}_n :

$$\alpha_{ij} = 2, -1, 0 \quad \text{if } |i - j| = 0, 1, \geq 2 \text{ respectively.}$$

PROPOSITION 7.12. *The algebra $U_q(\mathfrak{sl}_n)$ carries a Hopf algebra structure, such that the subalgebras $k\langle K_i^{\pm 1}, E_i, F_i \rangle$ are isomorphic to $U_q(\mathfrak{sl}_2)$.*

The proof requires several computations, which are omitted here.

THEOREM 7.13 (REPRESENTATIONS OF $U_q(\mathfrak{sl}_n)$) (Rosso). *If q is not a root of unity and $\text{char}(k) \neq 2$ then all finite dimensional representations of $U_q(\mathfrak{sl}_n)$ are completely reducible.*

The irreducible representations can be given explicitly, but this is rather complicated and we omit it here.

DEFINITION 7.14. The *basic representation* $\pi : U_q(\mathfrak{sl}_n) \rightarrow M_n(k)$ of $U_q(\mathfrak{sl}_n)$ is defined as the algebra map given by

$$K_i \mapsto I + (q - 1)\mathbb{E}_{ii} + (q^{-1} - 1)\mathbb{E}_{i+1,i+1}, E_i \mapsto \mathbb{E}_{i,i+1}, F_i \mapsto \mathbb{E}_{i+1,i}.$$

It is easy, but tedious, to verify that this is indeed a well-defined algebra map. (For $n = 2$, it is the map π_1 defined in Theorem 7.6.)

Theorem 7.9 generalizes to the case $n \geq 2$.

THEOREM 7.15 ($\mathcal{O}_q(\text{SL}(n))$ AS A HOPF SUBALGEBRA OF $U_q(\mathfrak{sl}_n)^\circ$). *Define $a_{ij} \in U_q(\mathfrak{sl}_n)^\circ$, for $i, j \in [1, n]$ by*

$$(a_{ij}(x))_{i,j} := \pi(x) \quad \text{for all } x \in U_q(\mathfrak{sl}_n).$$

Then there is an injective Hopf algebra map given by

$$\varphi : \mathcal{O}_q(\text{SL}(n)) \rightarrow U_q(\mathfrak{sl}_n)^\circ, \quad x_{ij} \mapsto a_{ij} \quad \text{for all } i, j \in [1, n].$$

PROOF. As before, we only show that φ is a (well-defined) Hopf algebra map (injectivity is not trivial and requires several computations).

As in the case $n = 2$, the family $(a_{ij})_{i,j}$ is a basis of $\text{Im}(\pi^*)$, such that

$$\Delta(a_{ij}) = \sum_{\ell=1}^n a_{i\ell} \otimes a_{\ell j}. \tag{7-4}$$

It remains to show that $(a_{ij})_{i,j}$ is an $(n \times n)$ q -matrix of q -determinant 1. Its entries are in $U_q(\mathfrak{sl}_n)^\circ$.

Let V_n be an n -dimensional k -vector space, with basis $\{e_1, \dots, e_n\}$. In a natural way, V_n is a left $M_n(k)$ -module; and it becomes a left $U_q(\mathfrak{sl}_n)$ -module via π . Hence, $V_n \otimes V_n$ is a left $U_q(\mathfrak{sl}_n)$ -module as well, via the comultiplication Δ .

It is easy (but tedious) to verify that

$$R_q : V_n \otimes V_n \rightarrow V_n \otimes V_n$$

is $U_q(\mathfrak{sl}_n)$ -linear (it suffices to do the calculations for generators of $U_q(\mathfrak{sl}_n)$ and basis elements of $V_n \otimes V_n$).

Hence, the q -exterior algebra $\bigwedge_q(V_n) = T(V_n)/\text{Ker}(R_q - qI)$ and the q -symmetric algebra $S_q(V_n)$ are $U_q(\mathfrak{sl}_n)$ -module algebras (cf. Definition 4.9).

Now, V_n is a right $U_q(\mathfrak{sl}_n)^\circ$ -comodule via

$$e_j \mapsto \sum_{i=1}^n e_i \otimes a_{ij},$$

and the above implies that R_q is a $U_q(\mathfrak{sl}_n)^\circ$ -comodule map. If we put $A = (a_{ij})$, this means $A^{(2)}$ commutes with R_q (cf. Lemma 4.8). Hence, A is a q -matrix by Proposition 1.6.

The subspace $k \cdot e_1 \cdot \dots \cdot e_n \subset \bigwedge_q(V_n)$ is a one-dimensional submodule (cf. Section 4), and it is not difficult to check that $U_q(\mathfrak{sl}_n)$ acts trivially on it (i.e. $u \cdot e_1 \cdot \dots \cdot e_n = \varepsilon(u)e_1 \cdot \dots \cdot e_n$), it suffices to verify this for generators. In other words, it is a trivial $U_q(\mathfrak{sl}_n)^\circ$ -comodule. This implies that (a_{ij}) has q -determinant 1.

Therefore, φ defines an algebra map. By (7-4), the map φ respects the comultiplication as well and is, hence, a Hopf algebra map. \square

Theorem 7.15 allows us to identify $\mathcal{O}_q(\mathrm{SL}(n))$ with a Hopf subalgebra of $U_q(\mathfrak{sl}_n)^\circ$.

Also Corollary 7.10 generalizes to the case $n \geq 2$. Firstly, note that algebra maps γ_i are defined (for $i \in [1, n-1]$) by

$$\gamma_i : U_q(\mathfrak{sl}_n) \rightarrow k, \quad E_j, F_j \mapsto 0, \quad K_j \mapsto \begin{cases} 1, & \text{if } i \neq j, \\ -1, & \text{if } i = j. \end{cases}$$

This means that all γ_i are group-like elements in $U_q(\mathfrak{sl}_n)^\circ$. It is easy to see that they generate a group isomorphic to \mathbb{Z}_2^{n-1} .

Conjugation with γ_i is given as follows:

$$\gamma_i a_{st} \gamma_i^{-1} = \begin{cases} a_{st}, & \text{if } i < s, t \text{ or } s, t \leq i, \\ -a_{st}, & \text{if } s \leq i < t \text{ or } t \leq i < s. \end{cases} \quad (7-5)$$

In particular, the γ_i normalize the Hopf subalgebra $\mathcal{O}_q(\mathrm{SL}(n))$ of $U_q(\mathfrak{sl}_n)^\circ$.

Using the explicit description of all irreducible representations of $U_q(\mathfrak{sl}_n)$, one can prove the following result:

THEOREM 7.16 (THE HOPF ALGEBRA STRUCTURE OF $U_q(\mathfrak{sl}_n)^\circ$). *If q is not a root of unity and $\mathrm{char}(k) \neq 2$, then*

$$U_q(\mathfrak{sl}_n)^\circ = \mathcal{O}_q(\mathrm{SL}(n)) \rtimes \mathbb{Z}_2^{n-1},$$

with respect to the action of $\mathbb{Z}_2^{n-1} = \langle \gamma_1, \dots, \gamma_{n-1} \rangle$ on $\mathcal{O}_q(\mathrm{SL}(n))$ given in (7-5).

8. Skew Primitive Elements

In this section, we determine all group-like and skew primitive elements of $\mathcal{O}_q(\mathrm{GL}(n))^\circ$. We assume throughout that q is not a root of unity.

Recall from the last section, that we have an injective Hopf algebra map $\varphi : \mathcal{O}_q(\mathrm{SL}(n)) \rightarrow U_q(\mathfrak{sl}_n)^\circ$.

One can show that the associated pairing $\mathcal{O}_q(\mathrm{SL}(n)) \otimes U_q(\mathfrak{sl}_n) \rightarrow k$ is non-degenerate, i.e., we obtain injective maps

$$U_q(\mathfrak{sl}_n) \hookrightarrow \mathcal{O}_q(\mathrm{SL}(n))^\circ \xrightarrow{\subset} \mathcal{O}_q(\mathrm{GL}(n))^\circ.$$

In the sequel, we consider $U_q(\mathfrak{sl}_n)$ as a sub Hopf algebra of $\mathcal{O}_q(\mathrm{GL}(n))^\circ$.

The basic representation $\pi : U_q(\mathfrak{sl}_n) \rightarrow M_n(k)$ extends to an algebra map

$$\tilde{\pi} : \mathcal{O}_q(\mathrm{GL}(n))^\circ \rightarrow M_n(k), \quad f \mapsto (f(x_{ij}))_{i,j} \tag{8-1}$$

(where (x_{ij}) denotes the canonical set of generators of $\mathcal{O}_q(\mathrm{GL}(n))$).

Recall that the set of group-like elements of a Hopf algebra H is denoted by $G(H)$. Given $g, h \in G(H)$, the set of (g, h) -skew primitive elements is

$$P_{g,h}(H) := \{u \in H \mid \Delta(u) = g \otimes u + u \otimes h\}.$$

In particular, $P(H) := P_{1,1}(H)$ is called the set of *primitive* elements of H . It is always a Lie algebra ($x, y \in P(H)$ implies $xy - yx \in P(H)$).

Note that, in any case, $g - h \in P_{g,h}(H)$. We call $P_{g,h}(H)$ *trivial*, if it is spanned by this element.

To determine all skew primitive elements of H , it suffices to determine all $(1, g)$ -skew primitive elements for all $g \in G(H)$, since for any $\gamma \in G(H)$, we have

$$\gamma P_{g,h}(H) = P_{\gamma g, \gamma h}(H), \quad P_{g,h}(H)\gamma = P_{g\gamma, h\gamma}(H).$$

In the following, we put $H := \mathcal{O}_q(\mathrm{GL}(n))^\circ$. We start with some examples of group-like and skew primitive elements of H .

REMARK 8.1. The elements K_1, \dots, K_{n-1} are group-like in H and $1 - K_i, E_i, K_i F_i$ are linearly independent $(1, K_i)$ -skew primitive elements of H .

Note that

$$\mathcal{O}(T) := \mathcal{O}_q(\mathrm{GL}(n)) / (x_{ij} \mid i \neq j)$$

is a factor Hopf algebra of $\mathcal{O}_q(\mathrm{GL}(n))$, which is naturally isomorphic to the group Hopf algebra $k\langle \mathbb{Z}^n \rangle$.

The corresponding quantum subgroup $T \subset \mathrm{GL}_q(n)$ is called *canonical maximal torus* (cf. Definition 4.16).

The dual Hopf algebra $\mathcal{O}(T)^\circ$ is isomorphic to the function algebra $(k\langle \mathbb{Z}^n \rangle)^\circ$ on the group \mathbb{Z}^n , hence has an n -dimensional space of primitive elements.

Since $\mathcal{O}(T)^\circ \subset \mathcal{O}_q(\mathrm{GL}(n))^\circ = H$, the space $P(H)$ is at least n -dimensional. We will show that it has exactly this dimension.

The first aim is to determine all group-like elements of H .

LEMMA 8.2 (q -MATRICES WITH SCALAR ENTRIES). *An invertible $(n \times n)$ -matrix $c = (c_{ij})$ with entries in k is a q -matrix if and only if it is diagonal.*

PROOF. Assume that $c_{11} = 0$. Since c is invertible, there are $i, j > 1$, such that $c_{1j}, c_{i1} \neq 0$. By the q -relations for c , we get $(q - q^{-1})c_{1j}c_{i1} = c_{ij}0 - 0c_{ij} = 0$, hence $q^2 = 1$, contradicting our assumption on q .

Therefore, $c_{11} \neq 0$. Since $q \neq 1$, the relation $c_{1j}c_{11} = qc_{11}c_{1j}$ implies that $c_{1j} = 0$, for all $j > 1$. Similarly, we obtain $c_{i1} = 0$, for all $i > 1$.

Since $(c_{ij})_{i,j \geq 2}$ is a q -matrix as well, it follows by induction that c is diagonal.

Conversely, a diagonal matrix over k is obviously a q -matrix. \square

PROPOSITION 8.3 (THE GROUP-LIKE ELEMENTS OF H). *The algebra map $\tilde{\pi} : H \rightarrow M_n(k)$ defined in (8-1) induces an isomorphism of groups $\pi : G(H) \rightarrow T(k)$, where $T(k)$ denotes the group of invertible diagonal matrices in $M_n(k)$.*

PROOF. The group-like elements in $H = \mathcal{O}_q(\mathrm{GL}(n))^\circ$ are exactly the algebra maps

$$g : \mathcal{O}_q(\mathrm{GL}(n)) \rightarrow k,$$

and these are in one-to-one correspondence with the invertible $(n \times n)$ q -matrices with entries in k . According to Lemma 8.2, these are exactly the invertible diagonal matrices, which proves the claim. \square

Now we determine all skew primitive elements of H .

Let C_3 denote the 3-dimensional coalgebra, with basis (β, γ, δ) , such that γ, δ are group-like and β is (γ, δ) -skew primitive.

Fix two group-like elements $g, h \in G(H)$ and let

$$\mathrm{diag}(g_1, \dots, g_n) := \pi(g), \quad \mathrm{diag}(h_1, \dots, h_n) := \pi(h) \quad (8-2)$$

denote the corresponding matrices in $T(k)$.

The elements $u \in P_{g,h}(H)$ are in one-to-one correspondence with the coalgebra maps $\varphi : C_3 \rightarrow H$, such that $(\beta, \gamma, \delta) \mapsto (u, g, h)$.

Note that the dual algebra C_3^* is isomorphic to the algebra $M_2^+(k)$ of upper triangular matrices in $M_2(k)$, via

$$C_3^* \rightarrow M_2^+(k), \quad f \mapsto \begin{pmatrix} f(\gamma) & f(\beta) \\ & f(\delta) \end{pmatrix}.$$

Since $H = \mathcal{O}_q(\mathrm{GL}(n))^\circ$, the coalgebra maps φ considered before give rise to algebra maps of the following form

$$\psi : \mathcal{O}_q(\mathrm{GL}(n)) \rightarrow C_3^* \cong M_2^+(k), \quad x_{ij} \mapsto \begin{pmatrix} g(x_{ij}) & u(x_{ij}) \\ & h(x_{ij}) \end{pmatrix}. \quad (8-3)$$

An algebra map is given by (8-3) if and only if $(\psi(x_{ij}))_{i,j}$ is an invertible q -matrix (with entries in $M_2^+(k)$). Note that, by definition, we have $g(x_{ij}) = \delta_{ij}g_i$ and $h(x_{ij}) = \delta_{ij}h_i$; compare (8-2) and (8-1). The correspondence $\varphi \leftrightarrow \psi$ is one-to-one.

Take any $u \in H$, write $c_{ij} := u(x_{ij})$ and

$$\tilde{C} := (\tilde{c}_{ij}), \quad \tilde{c}_{ij} := \begin{pmatrix} \delta_{ij}g_i & c_{ij} \\ & \delta_{ij}h_i \end{pmatrix}.$$

By the observations before, $u \in P_{g,h}(H)$ implies that \tilde{C} is an invertible q -matrix.

LEMMA 8.4. Assume \tilde{C} is a q -matrix.

- (a) For all $i < j$, we have $(h_i - qg_i)c_{ij} = (h_i - qg_i)c_{ji} = (g_j - qh_j)c_{ij} = (g_j - qh_j)c_{ji} = 0$.
- (b) For all $i < j$, we have $(g_j - h_j)c_{ii} = (g_i - h_i)c_{jj}$.
- (c) If $|i - j| \geq 2$ then $c_{ij} = 0$.
- (d) If $c_{i,i+1} \neq 0$ or $c_{i+1,i} \neq 0$ then $g^{-1}h = K_i$.

PROOF. Suppose $i < j$. By the q -relations for \tilde{C} ,

$$\begin{pmatrix} 0 & c_{ij} \\ 0 & 0 \end{pmatrix} \begin{pmatrix} g_i & c_{ii} \\ 0 & h_i \end{pmatrix} = \tilde{c}_{ij}\tilde{c}_{ii} = q\tilde{c}_{ii}\tilde{c}_{ij} = q \begin{pmatrix} g_i & c_{ii} \\ 0 & h_i \end{pmatrix} \begin{pmatrix} 0 & c_{ij} \\ 0 & 0 \end{pmatrix}.$$

Comparing the matrix entries yields $c_{ij}h_i = qg_ic_{ij}$, hence $(h_i - qg_i)c_{ij} = 0$. The other relations in (a) are shown similarly.

Moreover, the q -relations for \tilde{C} give

$$\tilde{c}_{jj}\tilde{c}_{ii} - \tilde{c}_{ii}\tilde{c}_{jj} = (q - q^{-1})\tilde{c}_{ij}\tilde{c}_{ji} = \begin{pmatrix} 0 & * \\ 0 & 0 \end{pmatrix} \begin{pmatrix} 0 & * \\ 0 & 0 \end{pmatrix} = 0,$$

hence, \tilde{c}_{ii} and \tilde{c}_{jj} commute. Since

$$\tilde{c}_{jj}\tilde{c}_{ii} = \begin{pmatrix} g_j & c_{jj} \\ 0 & h_j \end{pmatrix} \begin{pmatrix} g_i & c_{ii} \\ 0 & h_i \end{pmatrix} = \begin{pmatrix} g_i g_j & g_j c_{ii} + h_i c_{jj} \\ 0 & h_i h_j \end{pmatrix},$$

it follows that $g_j c_{ii} + c_{jj} h_i = g_i c_{jj} + c_{ii} h_j$, which implies (b).

To show (c), suppose $i < j < k$. We claim $c_{ik} = 0$. Using the q -relations for \tilde{C} , we get

$$(q - q^{-1})\tilde{c}_{jj}\tilde{c}_{ik} = [\tilde{c}_{jk}, \tilde{c}_{ij}] = \left[\begin{pmatrix} 0 & * \\ 0 & 0 \end{pmatrix}, \begin{pmatrix} 0 & * \\ 0 & 0 \end{pmatrix} \right] = 0.$$

Since $q^2 \neq 1$ and \tilde{c}_{jj} is (by definition) invertible, it follows that $\tilde{c}_{ik} = 0$, hence $c_{ik} = 0$. It is checked similarly that $c_{ki} = 0$, so (c) is proved.

Now assume $c_{i,i+1} \neq 0$. The relations in (a) imply $h_i = qg_i$ and $g_{i+1} = qh_{i+1}$. It remains to show $g_j = h_j$ for all $j \notin \{i, i+1\}$ (then $\pi(g^{-1}h) = \pi(K_i)$ and the claim follows from Proposition 8.3).

By (c), we have $\tilde{c}_{j,i+1} = 0$ if $j < i$, and $\tilde{c}_{ij} = 0$ if $i+1 < j$. In both cases, the q -relations for \tilde{C} imply that \tilde{c}_{jj} and $\tilde{c}_{i,i+1}$ commute. One calculates

$$\tilde{c}_{jj}\tilde{c}_{i,i+1} = \begin{pmatrix} 0 & g_j c_{i,i+1} \\ 0 & 0 \end{pmatrix}, \quad \tilde{c}_{i,i+1}\tilde{c}_{jj} = \begin{pmatrix} 0 & c_{i,i+1} h_j \\ 0 & 0 \end{pmatrix}.$$

Hence, $g_j c_{i,i+1} = c_{i,i+1} h_j$, which implies $g_j = h_j$ (since $c_{i,i+1} \neq 0$).

The case $c_{i+1,i} \neq 0$ is treated similarly. □

THEOREM 8.5 (THE SKEW PRIMITIVE ELEMENTS OF $\mathcal{O}_q(\mathrm{GL}(n))^\circ$). Let $H := \mathcal{O}_q(\mathrm{GL}(n))^\circ$ and $g, h \in G(H)$.

- (a) $P_{g,h}(H)$ is trivial if and only if $g^{-1}h \notin \{1, K_1, \dots, K_{n-1}\}$.
- (b) If $g^{-1}h = K_i$, then $P_{g,h}(H)$ is 3-dimensional and spanned by $g-h, gE_i, hF_i$.
- (c) $P(H)$ is n -dimensional and equal to $P(\mathcal{O}(T)^\circ)$, considering $\mathcal{O}(T)^\circ \subset H$.

PROOF. The restriction of $\tilde{\pi} : H \rightarrow M_n(k)$, $f \mapsto (f(x_{ij}))$ to the set $P_{g,h}(H)$ is injective (since the algebra map ψ (8-3) is determined by its values on algebra generators — but note that $\tilde{\pi}$ itself need not be injective).

Let $u \in P_{g,h}(H)$ and $c_{ij} := u(x_{ij})$, which means $c := (c_{ij}) = \tilde{\pi}(u)$.

(1) Suppose $g^{-1}h \notin \{1, K_1, \dots, K_{n-1}\}$. Then, by (c) and (d) of Lemma 8.4, the matrix c is diagonal. Moreover, (b) implies

$$(c_{11}, \dots, c_{nn}) = \lambda(g_1 - h_1, \dots, g_n - h_n),$$

for some scalar λ , which means $c = \tilde{\pi}(\lambda(g - h))$. Since $\tilde{\pi}$ is injective on skew primitive elements, $u = \lambda(g - h)$, so $P_{g,h}(H)$ is trivial.

(2) Suppose $g^{-1}h = K_i$, for some $1 \leq i < n$. By (c) and (d) of Lemma 8.4, the non-zero off-diagonal entries of c are at most $c_{i,i+1}$ and $c_{i+1,i}$. As before, (b) implies that

$$(c_{11}, \dots, c_{nn}) = \lambda(g_1 - h_1, \dots, g_n - h_n),$$

for some scalar λ .

It is easily checked that $g-h, gE_i, hF_i$ are (g, h) -skew primitive. One calculates

$$\tilde{\pi}(gE_i) = g_i \mathbb{E}_{i,i+1},$$

$$\tilde{\pi}(hF_i) = h_{i+1} \mathbb{E}_{i+1,i},$$

$$\tilde{\pi}(g - h) = \text{diag}(g_1 - h_1, \dots, g_n - h_n).$$

By injectivity, it follows that $P_{g,h}(H)$ is spanned by $(g - h, gE_i, hF_i)$.

(3) Let $g = h$. Then (c) and (d) of Lemma 8.4 imply that the matrix c is diagonal. Hence, $\tilde{\pi}$ maps $P_{g,g}(H) = gP(H)$ injectively to the set of diagonal matrices in $M_n(k)$. Therefore, $P_{g,g}(H)$ is at most n -dimensional.

The claim now follows from the observations after Remark 8.1. \square

The results of Theorem 8.5 still hold if we only assume $q^2 \neq 1$. However, the considered map $U_q(\mathfrak{sl}_n) \rightarrow \mathcal{O}_q(\text{GL}(n))^\circ$ is injective only if q is not a root of unity.

9. Group Homomorphisms $\text{SL}_q(n) \rightarrow \text{GL}_q(m)$

Recall that the category of quantum groups is the opposite category of the category of Hopf algebras (Definition 4.16).

A morphism $\varrho : \text{SL}_q(n) \rightarrow \text{GL}_q(m)$ of quantum groups is thus a Hopf algebra map $\mathcal{O}(\varrho) : \mathcal{O}_q(\text{GL}(m)) \rightarrow \mathcal{O}_q(\text{SL}(n))$. In this section, we determine all such morphisms.

We assume that q is not a root of unity.

DEFINITION 9.1 (THE DERIVED HOMOMORPHISM). Let $\varrho : \text{SL}_q(n) \rightarrow \text{GL}_q(m)$ be a morphism of quantum groups. The dual map of

$$\mathcal{O}_q(\text{GL}(m)) \xrightarrow{\mathcal{O}(\varrho)} \mathcal{O}_q(\text{SL}(n)) \subset U_q(\mathfrak{sl}_n)^\circ$$

is called the *derived morphism* and denoted as $\partial\varrho : U_q(\mathfrak{sl}_n) \rightarrow \mathcal{O}_q(\text{GL}(m))^\circ$.

REMARK 9.2. The map $\partial\rho$ is determined by its values on all K_i, E_i, F_i ; moreover, $\partial\rho_1 = \partial\rho_2$ implies $\rho_1 = \rho_2$.

PROOF. The first property is obvious. Now suppose $\rho : \mathrm{SL}_q(n) \rightarrow \mathrm{GL}_q(m)$. It is straightforward to check that the following diagram commutes:

$$\begin{array}{ccc} \mathcal{O}_q(\mathrm{GL}(m)) & \xrightarrow{\text{can}} & \mathcal{O}_q(\mathrm{GL}(m))^{\circ\circ} \\ \mathcal{O}(\rho) \downarrow & & \downarrow (\partial\rho)^\circ \\ \mathcal{O}_q(\mathrm{SL}(n)) & \xrightarrow{\varphi} & \mathrm{U}_q(\mathfrak{sl}_n)^\circ \end{array}$$

where φ is as in Theorem 7.15 and can denotes the canonical map. Since φ is injective, $\mathcal{O}(\rho)$ and, hence, ρ are uniquely determined by $\partial\rho$. \square

A quantum group G can be considered, equivalently, as the functor

$$G : \mathrm{Alg}_k \rightarrow \mathrm{Set}, R \mapsto G(R) := \mathrm{Alg}_k(\mathcal{O}(G), R),$$

where Alg_k denotes the category of k -algebras and Set the category of sets.

We adopt this point of view in this section.

LEMMA 9.3. *There is no nontrivial morphism $\mathrm{SL}_q(2) \rightarrow G_m$ ($:= \mathrm{GL}_q(1)$).*

PROOF. The quantum group G_m corresponds to the group Hopf algebra $k[\mathbb{Z}]$. The algebra maps from $k[\mathbb{Z}]$ to an algebra R are in 1-to-1 correspondence with the invertible elements of R (this explains the name “ G_m ”: multiplicative group of units).

Suppose $f : \mathrm{SL}_q(2) \rightarrow G_m$ is a morphism (of quantum groups). There is an embedding $G_m \hookrightarrow \mathrm{SL}_q(2)$, given by

$$G_m(R) \rightarrow \mathrm{SL}_q(2)(R), a \mapsto \begin{pmatrix} a & \\ & a^{-1} \end{pmatrix}.$$

Consider $G_m \hookrightarrow \mathrm{SL}_q(2) \xrightarrow{f} G_m$. There is some $N \in \mathbb{Z}$, such that this morphism is given by

$$G_m(R) \rightarrow G_m(R), a \mapsto a^N.$$

It follows that $\partial f : \mathrm{U}_q(\mathfrak{sl}_2) \rightarrow \mathcal{O}(G_m)^\circ$ maps K — which corresponds to $\begin{pmatrix} q & \\ & q^{-1} \end{pmatrix}$ — to q^N . (We identify group-like elements in $\mathcal{O}(G_m)^\circ$ with non-zero elements in k ; see Proposition 8.3).

Since $\mathcal{O}(G_m)^\circ$ is commutative and $KEK^{-1} = q^2E$, it follows that $\partial f(E) = 0$, similarly $\partial f(F) = 0$. We obtain

$$q^N - q^{-N} = \partial f(K - K^{-1}) = (q - q^{-1})\partial f(EF - FE) = 0,$$

which implies $N = 0$, since q is not a root of unity. Hence, ∂f is trivial, so f is trivial as well. \square

PROPOSITION 9.4. *Let $\varrho : \mathrm{SL}_q(2) \rightarrow \mathrm{GL}_q(m)$ be a nontrivial morphism of quantum groups ($m > 1$). Then there is some $i < m$ and $c \in k^\times$, such that*

$$\partial\varrho(K) = K_i, \quad \partial\varrho(E) = cE_i, \quad \partial\varrho(F) = c^{-1}F_i.$$

PROOF. Let $T \subset \mathrm{GL}_q(m)$ denote the canonical maximal torus (Section 8). By Proposition 8.3, $\mathcal{O}(T)^\circ$ and $\mathcal{O}_q(\mathrm{GL}(m))^\circ$ have the same group-like elements. Since $\partial\varrho(K)$ is group-like, $\partial\varrho(K) \in \mathcal{O}(T)^\circ$.

Assume $\partial\varrho(E) = \partial\varrho(F) = 0$. Then the image of $\partial\varrho$ is contained in $\mathcal{O}(T)^\circ$, which means that $\mathrm{Im}(\varrho) \subset T$. But T is isomorphic to the direct product of n copies of G_m . Hence, by Lemma 9.3, the morphism ϱ is trivial, contradicting the hypothesis.

Therefore, $\partial\varrho(E), \partial\varrho(F)$ are not both zero. Suppose $\partial\varrho(E) \neq 0$. Then $\partial\varrho(E)$ is a nontrivial $(1, \partial\varrho(K))$ -skew primitive element. It follows from Theorem 8.5 that $\partial\varrho(K) = K_i$, for some $i < m$ (it is impossible that $\partial\varrho(K) = 1$, since conjugation with $\partial\varrho(K)$ is not the identity on $\partial\varrho(E)$).

The space of $(1, K_i)$ -primitive elements is spanned by $(1 - K_i, E_i, K_i F_i)$ (cf. Theorem 8.5). Since

$$K_i \partial\varrho(E) K_i^{-1} = \partial\varrho(KEK^{-1}) = q^2 \partial\varrho(E),$$

we get $\partial\varrho(E) = cE_i$, for some $c \in k^\times$.

The relation

$$0 \neq K_i - K_i^{-1} = (q - q^{-1})[\partial\varrho(E), \partial\varrho(F)] \quad (9-1)$$

implies $\partial\varrho(F) \neq 0$. Similarly as above, we get $\partial\varrho(F) = c'F_i$ for some $c' \in k^\times$, and from (9-1) again, it follows that $cc' = 1$. \square

Conversely, there actually *exist* morphisms as described in Proposition 9.4:

DEFINITION 9.5. Suppose $m > 1$. For $0 \leq s < m - 1$, the morphism $\eta^{(s)} : \mathrm{SL}_q(2) \rightarrow \mathrm{SL}_q(m)$ is defined as follows:

$$\eta^{(s)}(R) : \mathrm{SL}_q(2)(R) \rightarrow \mathrm{SL}_q(m)(R), \quad A \mapsto \begin{pmatrix} I_s & & \\ & A & \\ & & I_{m-2-s} \end{pmatrix}$$

(for any algebra R , where I_n denotes the $(n \times n)$ -identity matrix).

For $a, b \in k^\times$, the morphism $\mathrm{inn}(a, b) : \mathrm{SL}_q(2) \rightarrow \mathrm{SL}_q(2)$ is defined by

$$\mathrm{inn}(a, b)(R) : \mathrm{SL}_q(2)(R) \rightarrow \mathrm{SL}_q(2)(R), \quad A \mapsto \begin{pmatrix} a & \\ & b \end{pmatrix} A \begin{pmatrix} a & \\ & b \end{pmatrix}^{-1}$$

(for any algebra R).

REMARK 9.6. The derived maps are given as follows:

$$\begin{aligned} \partial\eta^{(s)} : \quad K, E, F &\mapsto K_{s+1}, E_{s+1}, F_{s+1}, \\ \partial\mathrm{inn}(a, b) : \quad K, E, F &\mapsto K, ab^{-1}E, a^{-1}bF. \end{aligned}$$

We summarize what has been proved so far:

PROPOSITION 9.7 (MORPHISMS $SL_q(2) \rightarrow GL_q(m)$). *Nontrivial morphisms of quantum groups $SL_q(2) \rightarrow GL_q(m)$ exist only if $m > 1$. In this case, all of them are exhausted by the compositions $\text{inn}(a, b)\eta^{(s)}$ for $0 \leq s < m - 1$ and $a, b \in k^\times$.*

We now turn to the general case. Let $\varrho : SL_q(n) \rightarrow GL_q(m)$ be a nontrivial morphism.

By applying Proposition 9.7 to $\varrho\eta^{(s)}$, for $0 \leq s < m - 1$, we obtain the following result:

There is a non-empty set $I \subset [1, n - 1]$, a map $\sigma : I \rightarrow [1, m - 1]$, and $c_i \in k^\times$, for $i \in I$, such that

$$\partial\varrho : K_i, E_i, F_i \mapsto \begin{cases} K_{\sigma(i)}, c_i E_{\sigma(i)}, c_i^{-1} F_{\sigma(i)} & \text{if } i \in I, \\ 1, 0, 0 & \text{if } i \notin I. \end{cases}$$

LEMMA 9.8. *Writing (α_{ij}) for the Cartan matrix of \mathfrak{sl}_n (Definition 7.11), we have:*

- (a) $I = [1, n - 1]$;
- (b) $\alpha_{ij} = \alpha_{\sigma(i), \sigma(j)}$;
- (c) σ is injective, in particular $n \leq m$;
- (d) if $|i - j| = 1$ then $|\sigma(i) - \sigma(j)| = 1$.

PROOF. (a) Suppose $j \in I$ and $|i - j| = 1$. Then $K_i E_j K_i^{-1} = q^{-1} E_j$. Application of $\partial\varrho$ yields

$$\partial\varrho(K_i) E_{\sigma(j)} \partial\varrho(K_i^{-1}) = q^{-1} E_{\sigma(j)},$$

in particular, $\partial\varrho(K_i) \neq 1$, which means $i \in I$. This proves $I = [1, n - 1]$.

(b) By the relations of $U_q(\mathfrak{sl}_n)$, we have $K_i E_j K_i^{-1} = q^{\alpha_{ij}} E_j$. We apply $\partial\varrho$ and get

$$K_{\sigma(i)} E_{\sigma(j)} K_{\sigma(i)}^{-1} = q^{\alpha_{ij}} E_{\sigma(j)}.$$

Since the left hand side is equal to $q^{\alpha_{\sigma(i), \sigma(j)}} E_{\sigma(j)}$ and q is not a root of unity, we get $\alpha_{\sigma(i), \sigma(j)} = \alpha_{ij}$.

Parts (c) and (d) follow from (b), since $i = j$ if and only if $\alpha_{ij} = 2$, and $|i - j| = 1$ if and only if $\alpha_{ij} = -1$. \square

It is easily checked that the maps $\sigma : [1, n - 1] \rightarrow [1, m - 1]$ of the form described in Lemma 9.8 are precisely the maps of the form

$$\sigma_s, \sigma'_s : [1, n - 1] \rightarrow [1, m - 1], \quad \sigma_s(i) := s + i, \quad \sigma'_s(i) := s + n - i,$$

for $0 \leq s \leq m - n$. We have proved the following:

PROPOSITION 9.9. *Let $\varrho : SL_q(n) \rightarrow GL_q(m)$ be a nontrivial morphism of quantum groups. Then $m \geq n$, and there are $0 \leq s \leq m - n$ and $c_i \in k^\times$, for $1 \leq i < n$, such that*

$$\begin{aligned} \partial\varrho : K_i, E_i, F_i &\mapsto K_{s+i}, c_i E_{s+i}, c_i^{-1} F_{s+i} && \text{for } 1 \leq i < n, \\ \text{or } \partial\varrho : K_i, E_i, F_i &\mapsto K_{s+n-i}, c_i E_{s+n-i}, c_i^{-1} F_{s+n-i} && \text{for } 1 \leq i < n. \end{aligned}$$

We show that morphisms of the form described above do exist.

DEFINITION 9.10. Suppose $m \geq n$. For $0 \leq s \leq m - n$, the morphism $\eta^{(s)} : \mathrm{SL}_q(n) \rightarrow \mathrm{SL}_q(m)$ is defined as follows:

$$\eta^{(s)}(R) : \mathrm{SL}_q(n)(R) \rightarrow \mathrm{SL}_q(m)(R), \quad A \mapsto \begin{pmatrix} I_s & & \\ & A & \\ & & I_{m-n-s} \end{pmatrix}.$$

For $a_1, \dots, a_n \in k^\times$, the morphism $\mathrm{inn}(a_1, \dots, a_n) : \mathrm{SL}_q(n) \rightarrow \mathrm{SL}_q(n)$ is defined by

$$\begin{aligned} \mathrm{inn}(a_1, \dots, a_n)(R) : \mathrm{SL}_q(n)(R) &\rightarrow \mathrm{SL}_q(n)(R), \\ A &\mapsto \mathrm{diag}(a_1, \dots, a_n)A \mathrm{diag}(a_1, \dots, a_n)^{-1} \end{aligned}$$

(for any algebra R).

REMARK 9.11. The derived maps are given by

$$\begin{aligned} \partial\eta^{(s)} : \quad K_i, E_i, F_i &\mapsto K_{s+i}, E_{s+i}, F_{s+i}, \\ \partial\mathrm{inn}(a_1, \dots, a_n) : \quad K_i, E_i, F_i &\mapsto K_i, a_i a_{i+1}^{-1} E_i, a_i^{-1} a_{i+1} F_i. \end{aligned}$$

LEMMA 9.12. *There is exactly one automorphism Φ of the quantum group $\mathrm{SL}_q(n)$, such that*

$$\partial\Phi : K_i, E_i, F_i \mapsto K_{n-i}, E_{n-i}, F_{n-i},$$

for all $i \in [1, n-1]$. If $n = 2$ then Φ is the identity, otherwise, Φ has order 2.

PROOF. Let (x_{ij}) denote, as usual, the canonical generators of $\mathcal{O}_q(\mathrm{GL}(n))$. There is an automorphism

$$\begin{aligned} I := \mathrm{inn} \mathrm{diag}(-q, (-q)^2, \dots, (-q)^n) : \mathcal{O}_q(\mathrm{GL}(n)) &\rightarrow \mathcal{O}_q(\mathrm{GL}(n)), \\ x_{ij} &\mapsto (-q)^{i-j} x_{ij}, \end{aligned}$$

an anti-automorphism

$$\Gamma : \mathcal{O}_q(\mathrm{GL}(n)) \rightarrow \mathcal{O}_q(\mathrm{GL}(n)), \quad x_{ij} \mapsto x_{n+1-j, n+1-i},$$

and the antipode (cf. Definition 4.12 and the proof of Theorem 4.15)

$$S : \mathcal{O}_q(\mathrm{GL}(n)) \rightarrow \mathcal{O}_q(\mathrm{GL}(n)), \quad x_{ij} \mapsto (-q)^{j-i} |X_{ji}|_q |X|_q^{-1}.$$

It can be shown by checking on generators that Γ, I, S commute with one another. Moreover, $\Gamma^2 = \mathrm{id}$, $S^2 = I^{-2}$ and $\Gamma(|X|_q) = I(|X|_q) = |X|_q$, $S(|X|_q) = |X|_q^{-1}$.

It follows that the composite $\mathcal{O}(\Phi) := S\Gamma I$ is an automorphism of $\mathcal{O}_q(\mathrm{GL}(n))$, given on generators by

$$\mathcal{O}(\Phi)(x_{ij}) = |X_{n+1-i, n+1-j}|_q |X|_q^{-1}.$$

Since $\mathcal{O}(\Phi)$ maps the quantum determinant to its inverse, $\mathcal{O}(\Phi)$ induces an automorphism of $\mathcal{O}_q(\mathrm{SL}(n))$. Direct calculation shows that $\partial\Phi$ has the described form. \square

Summarizing these results, we get the following main theorem:

THEOREM 9.13 (ALL MORPHISMS $SL_q(n) \rightarrow GL_q(m)$). *Nontrivial morphisms of quantum groups $SL_q(n) \rightarrow GL_q(m)$ exist only if $n \leq m$. If this is the case, all of them are exhausted by*

$$\text{inn}(a_1, \dots, a_n)\eta^{(s)}, \quad \text{inn}(a_1, \dots, a_n)\Phi\eta^{(s)},$$

for $0 \leq s \leq m - n$ and $a_1, \dots, a_n \in k^\times$.

In particular:

COROLLARY 9.14 (ENDOMORPHISMS AND AUTOMORPHISMS OF $SL_q(n)$).

- (a) *Every nontrivial endomorphism of the quantum group $SL_q(n)$ is an automorphism.*
- (b) *Every automorphism of $SL_q(n)$ is inner (by a diagonal matrix in k) or the composite with Φ .*

Theorem 9.13 is valid (more generally) if $q^2 \neq 1$ or $q = -1$, $\text{char}k = 0$.

The endomorphism theorem (Corollary 9.14(a)) is valid if $q^2 \neq 1$ or $\text{char}k = 0$.

The automorphism theorem (Corollary 9.14(b)) is valid for $GL_q(n)$ and $SL_q(n)$ if $q^2 \neq 1$. It is valid for any $q \in k^\times$, if one replaces “diagonal matrix in k ” by “ q -matrix with entries in k ”.

10. The 2-Parameter Quantization

We now take invertible scalars α, β instead of the parameter q , and extend the results for q -matrices to those for (α, β) -matrices.

DEFINITION 10.1 (TWO-PARAMETER QUANTUM MATRICES). A (2×2) matrix $A = \begin{pmatrix} a & b \\ c & d \end{pmatrix}$ is called an (α, β) -matrix if the following relations hold:

$$\begin{aligned} ba &= \alpha ab, & dc &= \alpha cd, \\ ca &= \beta ac, & db &= \beta bd, \\ cb &= \beta\alpha^{-1}bc, & da - ad &= (\beta - \alpha^{-1})bc. \end{aligned}$$

The *quantum determinant* of A is defined by

$$\delta = ad - \alpha^{-1}bc = da - \beta bc,$$

and is denoted by $|A|_{\alpha, \beta}$ or simply by $|A|$.

Many of the results on q -matrices stated so far will be extended to (α, β) -matrices.

There are two analogues of the matrix \tilde{A} as follows:

$$A \begin{pmatrix} d & -\alpha b \\ -\alpha^{-1}c & a \end{pmatrix} = \begin{pmatrix} d & -\beta b \\ -\beta^{-1}c & a \end{pmatrix} A = \begin{pmatrix} \delta & 0 \\ 0 & \delta \end{pmatrix}.$$

This implies

$$\begin{pmatrix} d & -\beta b \\ -\beta^{-1}c & a \end{pmatrix} \delta = \begin{pmatrix} d & -\beta b \\ -\beta^{-1}c & a \end{pmatrix} A \begin{pmatrix} d & -\alpha b \\ -\alpha^{-1}c & a \end{pmatrix} = \delta \begin{pmatrix} d & -\alpha b \\ -\alpha^{-1}c & a \end{pmatrix},$$

so that δ commutes with a, d , but not with b, c . However, as in the one-parameter case, A is invertible if δ is invertible.

DEFINITION 10.2 (GENERAL TWO-PARAMETER QUANTUM MATRICES). An $(n \times n)$ matrix A is called an (α, β) -matrix, if any (2×2) minor in A is an (α, β) -matrix.

The matrix R_q (cf. Definition 4.2) is extended as follows:

$$R_{\alpha, \beta} := \alpha\beta \sum_{i=1}^n \mathbb{E}_{ii} \otimes \mathbb{E}_{ii} + \sum_{i < j} (\alpha \mathbb{E}_{ij} \otimes \mathbb{E}_{ji} + \beta \mathbb{E}_{ji} \otimes \mathbb{E}_{ij} + (\alpha\beta - 1) \mathbb{E}_{jj} \otimes \mathbb{E}_{ii}).$$

Note that $R_q = q^{-1} R_{q, q}$.

We may regard $R_{\alpha, \beta}$ as a linear transformation $V_n \otimes V_n \rightarrow V_n \otimes V_n$ defined by

$$R_{\alpha, \beta}(e_i \otimes e_j) = \begin{cases} \beta e_j \otimes e_i & \text{if } i < j, \\ \alpha \beta e_i \otimes e_j & \text{if } i = j, \\ \alpha e_j \otimes e_i + (\alpha\beta - 1) e_i \otimes e_j & \text{if } i > j. \end{cases}$$

The next proposition generalizes Proposition 4.3.

PROPOSITION 10.3 (THE R-MATRIX $R_{\alpha, \beta}$ AND (α, β) -MATRICES).

- (a) $R_{\alpha, \beta}$ is invertible and satisfies the braid condition (1-1).
- (b) We have $(R_{\alpha, \beta} - \alpha\beta I)(R_{\alpha, \beta} + I) = 0$.
- (c) An $(n \times n)$ matrix A is an (α, β) -matrix if and only if $A^{(2)}$ commutes with $R_{\alpha, \beta}$.

As in the case of $\mathcal{O}_q(\mathbb{M}(n))$, part (c) of this proposition ensures that the algebra $\mathcal{O}_{\alpha, \beta}(\mathbb{M}(n))$ defined by n^2 generators $x_{11}, x_{12}, \dots, x_{nn}$ and the relation that $X = (x_{ij})$ is an (α, β) -matrix forms in a natural way a bialgebra over which V_n is a right comodule (cf. Proposition 4.6 and Equation (4-1)).

Since $R_{\alpha, \beta} : V_n \otimes V_n \rightarrow V_n \otimes V_n$ is a right $\mathcal{O}_{\alpha, \beta}(\mathbb{M}(n))$ comodule isomorphism, it follows, by considering the images $\text{Im}(R_{\alpha, \beta} - \alpha\beta I)$ and $\text{Im}(R_{\alpha, \beta} + I)$, that $S_\alpha(V_n)$ and $\bigwedge_\beta(V_n)$ are right $\mathcal{O}_{\alpha, \beta}(\mathbb{M}(n))$ comodule algebras in a natural way (cf. Definition 4.9). Similarly, $S_\beta(V_n)$ and $\bigwedge_\alpha(V_n)$ are left $\mathcal{O}_{\alpha, \beta}(\mathbb{M}(n))$ comodule algebras.

The group-likes arising from the $\mathcal{O}_{\alpha, \beta}(\mathbb{M}(n))$ coaction on each n -th component of $\bigwedge_\alpha(V_n)$ and of $\bigwedge_\beta(V_n)$ coincide with each other, and are equal to

$$\begin{aligned} g &:= \sum_{\sigma \in S_n} (-\beta)^{-\ell(\sigma)} x_{\sigma(1), 1} \cdots x_{\sigma(n), n} \\ &= \sum_{\sigma \in S_n} (-\alpha)^{-\ell(\sigma)} x_{1, \sigma(1)} \cdots x_{n, \sigma(n)}. \end{aligned}$$

This is called the *quantum determinant* and is denoted by $|X|_{\alpha, \beta}$ or simply by $|X|$.

We have

$$X ((-\alpha)^{j-i}|X_{ji}|)_{i,j} = ((-\beta)^{j-i}|X_{ji}|)_{i,j} X = gI.$$

Since this implies that

$$\begin{aligned} X \operatorname{diag}((-\alpha)^{-1}, \dots, (-\alpha)^{-n})(|X_{ji}|)_{i,j} \operatorname{diag}(-\beta, \dots, (-\beta)^n)X \\ = g \operatorname{diag}(\alpha^{-1}\beta, \dots, (\alpha^{-1}\beta)^n)X \\ = X \operatorname{diag}(\alpha^{-1}\beta, \dots, (\alpha^{-1}\beta)^n)g, \end{aligned}$$

we have $x_{ij}g = (\beta\alpha^{-1})^{i-j}gx_{ij}$.

This allows us to define $\mathcal{O}_{\alpha,\beta}(\operatorname{GL}(n))$ to be the localization $\mathcal{O}_{\alpha,\beta}(\operatorname{M}(n))[g^{-1}]$. If we let g^{-1} be a group-like element, then $\mathcal{O}_{\alpha,\beta}(\operatorname{GL}(n))$ forms a Hopf algebra including $\mathcal{O}_{\alpha,\beta}(\operatorname{M}(n))$ as a sub-bialgebra.

The antipode S of $\mathcal{O}_{\alpha,\beta}(\operatorname{GL}(n))$ satisfies:

$$\begin{aligned} S(x_{ij}) &= (-\beta)^{j-i}g^{-1}|X_{ji}| = (-\alpha)^{j-i}|X_{ji}|g^{-1}, \\ S^2(x_{ij}) &= (\alpha\beta)^{j-i}x_{ij}. \end{aligned}$$

The Hopf algebra $\mathcal{O}_{\alpha,\beta}(\operatorname{GL}(n))$ defines the 2-parameter quantization $\operatorname{GL}_{\alpha,\beta}(n)$ of $\operatorname{GL}(n)$.

11. The q -Schur Algebra and the Hecke Algebra

Fix a non-zero element q in k and a non-negative integer n .

DEFINITION 11.1 (THE HECKE ALGEBRA). The Hecke algebra \mathcal{H} is the algebra generated by $n - 1$ elements T_1, \dots, T_{n-1} with the relations

$$(T_i - q)(T_i + 1) = 0, \tag{11-1}$$

$$T_i T_{i+1} T_i = T_{i+1} T_i T_{i+1}, \tag{11-2}$$

$$T_i T_j = T_j T_i \quad \text{if } |i - j| > 1. \tag{11-3}$$

PROPOSITION 11.2. Let $\pi \in S_n$ and suppose that $\pi = s_{i_1} \cdot \dots \cdot s_{i_\ell}$ is a reduced expression with the transpositions $s_a = (a, a+1)$. (Thus $\ell = \ell(\pi)$, the length of π .) Then

$$T_\pi := T_{i_1} \cdot \dots \cdot T_{i_\ell}$$

is independent of the choice of the reduced expression for π . Moreover, $\{T_\pi \mid \pi \in S_n\}$ is a basis of \mathcal{H} .

If $q = 1$, then $\mathcal{H} = kS_n$, the group algebra of the symmetric group S_n .

If $q = p^r$, a power of a prime p , then $\mathcal{H} = H_k(\operatorname{GL}_n(q), B)$, the Iwahori–Hecke algebra, with B the Borel subgroup.

DEFINITION 11.3 (THE q -SCHUR ALGEBRA). Suppose that $q = \alpha\beta$, where $\alpha, \beta \in k^\times$. The n -th component of $\mathcal{O}_{\alpha,\beta}(M(d))$ is denoted by $A(d, n)$; it is a subcoalgebra. The dual algebra

$$S(d, n) := A(d, n)^*$$

is determined by the product q , as we will see soon, so it is denoted by $S_q(d, n)$ and called the q -Schur algebra.

The vector space $(V_d)^{\otimes n}$ is a right $A(d, n)$ -comodule, with respect to the diagonal coaction by $\mathcal{O}_{\alpha,\beta}(M(d))$, which is given by

$$\begin{aligned} (V_d)^{\otimes n} &\rightarrow (V_d)^{\otimes n} \otimes A(d, n), \\ e_{i_1} \otimes \dots \otimes e_{i_n} &\mapsto \sum_{j_1, \dots, j_n} e_{j_1} \otimes \dots \otimes e_{j_n} \otimes x_{j_1, i_1} \cdot \dots \cdot x_{j_n, i_n}. \end{aligned}$$

Right $A(d, n)$ comodules are interpreted as polynomial representations of $\mathrm{GL}_{\alpha,\beta}(d)$ of degree n .

PROPOSITION 11.4. *The algebra $S(d, n)$ (with d, n fixed) is determined, up to isomorphism, by q (rather than α, β).*

This allows us to write $S_q(d, n) = S(d, n)$ and justifies the name “ q ”-Schur algebra.

PROOF. To see this, we first make $(V_d)^{\otimes n}$ into a right \mathcal{H} module by identifying

$$T_i = \mathrm{id}_{(V_d)^{\otimes(i-1)}} \otimes R_{\alpha,\beta} \otimes \mathrm{id}_{(V_d)^{\otimes(n-i-1)}},$$

a linear endomorphism of $(V_d)^{\otimes n}$, where $R_{\alpha,\beta}$ acts on $V_d \otimes V_d$ by left multiplication (this action is well-defined, cf. Proposition 10.3 (b)).

By the construction of $\mathcal{O}_{\alpha,\beta}(M(d))$, the coalgebra $A(d, n)$ is the “cocentralizer” of T_1, \dots, T_{n-1} , or in other words the largest quotient coalgebra of $\mathrm{End}((V_d)^{\otimes n})^*$, over which T_1, \dots, T_{n-1} are all comodule endomorphisms.

This means that $A(d, n)^*$ is the centralizer of T_1, \dots, T_{n-1} . Thus we have a natural isomorphism

$$S(d, n) \xrightarrow{\cong} \mathrm{End}_{\mathcal{H}}((V_d)^{\otimes n}).$$

Hence, it is enough to show that the right \mathcal{H} module $(V_d)^{\otimes n}$ is determined by q .

Let $i = (i_1, \dots, i_n)$ be an n -tuple of integers $1 \leq i_k \leq d$. Write $e_i = e_{i_1} \otimes \dots \otimes e_{i_n}$. All the e_i 's form a basis of $(V_d)^{\otimes n}$. For the transposition $s = (a, a+1)$, it follows from the definition of $T_s (= T_a)$ that

$$e_i T_s = \begin{cases} qe_i & \text{if } i_a = i_{a+1}, \\ \beta e_{is} & \text{if } i_a < i_{a+1}, \\ (q-1)e_i + \alpha e_{is} & \text{if } i_a > i_{a+1}. \end{cases}$$

where S_n acts naturally on the set of the n -tuples i from the right.

Define an equivalence relation among the n -tuples by

$$i \sim j \Leftrightarrow \exists \pi \in S_n : j = i\pi.$$

The equivalence classes are in one-to-one correspondence with the set $\Lambda(d, n)$ of the compositions $\lambda = (\lambda_1, \dots, \lambda_d)$ of n into d parts (i.e. $\lambda_1 + \dots + \lambda_d = n$, where all $\lambda_k \geq 0$). Here, i belongs to λ if and only if $i \sim i_\lambda$, where

$$i_\lambda := (\underbrace{1, \dots, 1}_{\lambda_1}, \underbrace{2, \dots, 2}_{\lambda_2}, \dots, \underbrace{d, \dots, d}_{\lambda_d}).$$

Clearly, the right \mathcal{H} module $(V_d)^{\otimes n}$ decomposes as

$$(V_d)^{\otimes n} = \bigoplus_{\lambda \in \Lambda(d, n)} \left(\bigoplus_{i \sim i_\lambda} ke_i \right),$$

a direct sum of the \mathcal{H} submodules $\bigoplus_{i \sim i_\lambda} ke_i$.

Fix some $\lambda = (\lambda_1, \dots, \lambda_d)$ in $\Lambda(d, n)$, and let $Y_\lambda (\subset S_n)$ denote the stabilizer of the d subsets $\{1, \dots, \lambda_1\}, \{\lambda_1 + 1, \dots, \lambda_1 + \lambda_2\}, \dots, \{\lambda_1 + \dots + \lambda_{d-1} + 1, \dots, n\}$.

Write $x_\lambda := \sum_{\pi \in Y_\lambda} T_\pi$.

PROPOSITION 11.5 (Dipper and James). *There is a right \mathcal{H} module isomorphism*

$$\bigoplus_{i \sim i_\lambda} ke_i \cong x_\lambda \mathcal{H}, \text{ given by } e_{i_\lambda} \mapsto x_\lambda.$$

Hence $(V_d)^{\otimes n} \cong \bigoplus_\lambda x_\lambda \mathcal{H}$, which implies that $(V_d)^{\otimes n}$, hence the algebra $S(d, n)$ also, is determined by q . □

COROLLARY 11.6. *If $\alpha\beta = \alpha'\beta'$, then $\mathcal{O}_{\alpha, \beta}(\mathcal{M}(n)) \cong \mathcal{O}_{\alpha', \beta'}(\mathcal{M}(n))$, as coalgebras.*

The q -Schur algebra was introduced by Dipper and James, and its representations have been investigated in detail.

REMARK 11.7 (Du, Parshall, Wang). The isomorphism mentioned in the last corollary is given explicitly as follows: Suppose $\alpha\beta = \alpha'\beta'$ and set $\xi := \alpha'/\alpha = \beta/\beta'$. Then there is a coalgebra isomorphism

$$\varphi_\xi : \mathcal{O}_{\alpha, \beta}(\mathcal{M}(n)) \xrightarrow{\cong} \mathcal{O}_{\alpha', \beta'}(\mathcal{M}(n)), x_{ij} \mapsto \xi^{\ell(i) - \ell(j)} x'_{ij},$$

where $x_{ij} := x_{i_1, j_1} \dots x_{i_r, j_r}$, $x'_{ij} := x'_{i_1, j_1} \dots x'_{i_r, j_r}$, denote the monomials which span $\mathcal{O}_{\alpha, \beta}(\mathcal{M}(n))$ and $\mathcal{O}_{\alpha', \beta'}(\mathcal{M}(n))$, respectively, and $\ell(i)$ is the number of inversions in i .

Furthermore, this isomorphism is extended uniquely to a coalgebra isomorphism

$$\mathcal{O}_{\alpha, \beta}(\text{GL}(n)) \xrightarrow{\cong} \mathcal{O}_{\alpha', \beta'}(\text{GL}(n)).$$

12. Cocycle Deformations

DEFINITION 12.1 (2-COCYCLES FOR A GROUP). A 2-cocycle for a group G (with coefficients in the trivial G -module k^\times) is a map $\sigma : G \times G \rightarrow k^\times$, which satisfies

$$\sigma(x, y)\sigma(xy, z) = \sigma(y, z)\sigma(x, yz), \quad x, y, z \in G.$$

Let us generalize this notion to a bialgebra A :

DEFINITION 12.2 (2-COCYCLES FOR A BIALGEBRA). A 2-cocycle for a bialgebra A is a bilinear form $\sigma : A \times A \rightarrow k$, that is invertible (in the algebra $(A \otimes A)^*$) and that satisfies

$$\sum \sigma(x_1, y_1)\sigma(x_2y_2, z) = \sum \sigma(y_1, z_1)\sigma(x, y_2z_2), \quad x, y, z \in A.$$

A 2-cocycle σ for A is said to be *normal*, if it satisfies

$$\sigma(1, x) = \varepsilon(x) = \sigma(x, 1), \quad x \in A.$$

For any 2-cocycle σ , the map $\sigma^{-1}(1, 1)\sigma$ is a normal 2-cocycle. In the following, we assume that all 2-cocycles are normal.

PROPOSITION 12.3 (DEFORMATION OF BIALGEBRAS BY 2-COCYCLES) (Doi).

(a) Using a 2-cocycle σ , define a new multiplication on A as follows

$$x \bullet y := \sum \sigma(x_1, y_1)x_2y_2\sigma^{-1}(x_3, y_3), \quad x, y \in A.$$

This makes A into an algebra with the same unit element.

(b) With this new algebra structure and the original coalgebra structure, A forms a bialgebra, which is denoted by A^σ . It is called the deformation of A by cocycle σ .

(c) If A is a Hopf algebra, A^σ is also a Hopf algebra, with the antipode S^σ , defined by

$$S^\sigma(x) = \sum \sigma(x_1, S(x_2))S(x_3)\sigma^{-1}(S(x_4), x_5), \quad x \in A.$$

EXAMPLE 12.4 (THE QUANTUM DOUBLE). Let H be a finite-dimensional Hopf algebra and define $A := H^{*\text{cop}} \otimes H$. The bilinear form $\sigma : A \times A \rightarrow k$ determined by

$$\sigma(p \otimes x, q \otimes y) = \langle p, 1 \rangle \langle q, x \rangle \langle \varepsilon, y \rangle$$

is a 2-cocycle for A . The algebra A^σ is a bicrossed product of H with $H^{*\text{cop}}$ determined by the following relations:

$$\begin{aligned} (p \otimes 1) \bullet (1 \otimes x) &= p \otimes x, \\ (1 \otimes x) \bullet (p \otimes 1) &= \sum \langle p_3, x_1 \rangle p_2 \otimes x_2 \langle p_1, S(x_3) \rangle, \end{aligned}$$

where $p \in H^*$, $x \in H$. Hence the Hopf algebra A^σ coincides with the *quantum double* $D(H)$ of H , which is due to Drinfeld.

In the remainder of this section, we shall consider mainly cocycle deformations of $\mathcal{O}_{\alpha,\beta}(M(n))$ and $\mathcal{O}_q(\mathrm{GL}(n))$.

We first generalize the construction of $\mathcal{O}_{\alpha,\beta}(M(n))$, following Doi's method.

DEFINITION 12.5 (THE BIALGEBRA $M(C, \sigma)$). Let C be a coalgebra, and let $\sigma : C \times C \rightarrow k$ be an invertible bilinear form. Let $M(C, \sigma)$ denote the quotient algebra of the tensor algebra $T(C)$ by the relation

$$\sum \sigma(x_1, y_1)x_2 \otimes y_2 = \sum \sigma(x_2, y_2)y_1 \otimes x_1, \quad x, y \in C.$$

In fact, $M(C, \sigma)$ is a quotient bialgebra of $T(C)$, where $T(C)$ has the unique bialgebra structure making C a subcoalgebra.

EXAMPLE 12.6 (THE BIALGEBRA $\mathcal{O}_{\alpha,\beta}(M(n))$). Define $C_n = M_n(k)^*$, and let $x_{ij} (\in C_n)$ be the dual basis of the matrix units $\mathbb{E}_{ij} (\in M_n(k))$. Define an invertible bilinear form $\sigma_{\alpha,\beta} : C_n \times C_n \rightarrow k$, where $\alpha, \beta \in k^\times$, by

$$\begin{aligned} \sigma_{\alpha,\beta}(x_{ii}, x_{jj}) &= \begin{cases} \beta, & \text{if } i < j, \\ \alpha\beta, & \text{if } i = j, \\ \alpha, & \text{if } i > j, \end{cases} \\ \sigma_{\alpha,\beta}(x_{ij}, x_{ji}) &= \alpha\beta - 1, \text{ if } i < j, \\ \sigma_{\alpha,\beta}(x_{ij}, x_{k\ell}) &= 0, \text{ otherwise.} \end{aligned}$$

This bilinear form is related with the linear transformation $R_{\alpha,\beta}$ (introduced below Definition 10.2) as follows:

$$R_{\alpha,\beta}(e_k \otimes e_\ell) = \sum_{i,j} \sigma_{\alpha,\beta}(x_{jk}, x_{i\ell})e_i \otimes e_j.$$

One sees the defining relations for $M(C_n, \sigma_{\alpha,\beta})$ are interpreted as $X^{(2)}R_{\alpha,\beta} = R_{\alpha,\beta}X^{(2)}$, so that we have (cf. Proposition 10.3 (c)):

$$M(C_n, \sigma_{\alpha,\beta}) = \mathcal{O}_{\alpha,\beta}(M(n)).$$

LEMMA 12.7. *Let τ be a 2-cocycle for $M(C, \sigma)$. Then there is a bialgebra isomorphism*

$$M(C, \sigma^\tau) \xrightarrow{\cong} M(C, \sigma)^\tau,$$

which is the identity on C , where $\sigma^\tau : C \times C \rightarrow k$ is the invertible bilinear form defined by

$$\sigma^\tau(x, y) = \sum \tau(y_1, x_1)\sigma(x_2, y_2)\tau^{-1}(x_3, y_3), \quad (x, y, z \in C). \quad (12-1)$$

DEFINITION 12.8. Braided bialgebras

A *braiding* on a bialgebra A is an invertible bilinear form $\sigma : A \times A \rightarrow k$ such

that for all $x, y, z \in A$, we have:

$$\begin{aligned}\sigma(xy, z) &= \sum \sigma(x, z_1)\sigma(y, z_2), \\ \sigma(x, yz) &= \sum \sigma(x_1, z)\sigma(x_2, y), \\ \sigma(x_1, y_1)x_2y_2 &= \sum y_1x_1\sigma(x_2, y_2).\end{aligned}$$

A braiding on A is a 2-cocycle for A . The last equation means that $A^\sigma = A^{\text{op}}$. The first and the last equations imply the following Yang–Baxter condition (for all $x, y, z \in A$):

$$\sum \sigma(x_1, y_1)\sigma(x_2, z_1)\sigma(y_2, z_2) = \sum \sigma(y_1, z_1)\sigma(x_1, z_2)\sigma(x_2, y_2). \quad (12-2)$$

If we regard σ as an element in $(A \otimes A)^*$, then the last equation is rewritten as

$$\sigma_{12}\sigma_{13}\sigma_{23} = \sigma_{23}\sigma_{13}\sigma_{12}$$

in the algebra $(A \otimes A \otimes A)^*$.

If σ is a braiding on A , then for any right A comodules V, W , it follows that

$$R_\sigma : V \otimes W \rightarrow W \otimes V, \quad v \otimes w \mapsto \sum \sigma(v_1, w_1)w_0 \otimes v_0$$

is a right A comodule isomorphism. The monoidal category of right A comodules becomes a braided category with the structure R_σ .

PROPOSITION 12.9 (A BRAIDING ON THE BIALGEBRA $\mathcal{O}_{\alpha, \beta}(M(n))$). *If an invertible bilinear form $\sigma : C \times C \rightarrow k$ satisfies the Yang–Baxter condition, then it is extended uniquely to a braiding on $M(C, \sigma)$.*

In particular, $\mathcal{O}_{\alpha, \beta}(M(n))$ has a natural braiding $\sigma_{\alpha, \beta}$ (the extension of $\sigma_{\alpha, \beta}$ in Example 12.6).

REMARK 12.10. If τ is a 2-cocycle for a bialgebra A and if σ is a braiding on A , then σ^τ as defined in (12-1) is a braiding on A^τ .

PROPOSITION 12.11. *Let $\alpha, \beta, \alpha', \beta' \in k^\times$. If $\alpha'\beta' = \alpha\beta$ or $(\alpha\beta)^{-1}$, then $\mathcal{O}_{\alpha', \beta'}(M(n))$ is a cocycle deformation of $\mathcal{O}_{\alpha, \beta}(M(n))$.*

PROOF. Let $T \subset M_{\alpha, \beta}(n)$ be the canonical maximal torus with the corresponding bialgebra projection

$$\mathcal{O}_{\alpha, \beta}(M(n)) \rightarrow \mathcal{O}(T) = k[t_1, t_1^{-1}, \dots, t_n, t_n^{-1}],$$

defined by $x_{ij} \mapsto \delta_{ij}t_i$. For $q \in k^\times$, set

$$\tau_q(t_1^{e(1)} \cdots t_n^{e(n)}, t_1^{f(1)} \cdots t_n^{f(n)}) = \prod_{i < j} q^{e(i)f(j)}.$$

Then τ_q gives a 2-cocycle for $\mathcal{O}(T)$, which may be regarded as a 2-cocycle for $\mathcal{O}_{\alpha, \beta}(M(n))$ through the projection. Since one computes

$$(\sigma_{\alpha, \beta})^{\tau_q} = \sigma_{q\alpha, q^{-1}\beta},$$

we get, using Lemma 12.7:

$$\mathcal{O}_{\alpha,\beta}(\mathbb{M}(n))^{\tau_q} \cong \mathcal{O}_{q\alpha,q^{-1}\beta}(\mathbb{M}(n)),$$

which yields the conclusion in the case where $\alpha'\beta' = \alpha\beta$.

For the assertion in the other case, it is enough to note that there is a bialgebra isomorphism

$$\mathcal{O}_{\alpha,\beta}(\mathbb{M}(n)) \cong \mathcal{O}_{\alpha^{-1},\beta^{-1}}(\mathbb{M}(n)), x_{ij} \mapsto x_{n+1-i,n+1-j}. \quad \square$$

We claim that the converse of Proposition 12.11 holds true.

THEOREM 12.12 (COCYCLE DEFORMATIONS OF $\mathcal{O}_{\alpha,\beta}(\mathbb{M}(n))$). *The bialgebra $\mathcal{O}_{\alpha',\beta'}(\mathbb{M}(n))$ is a cocycle deformation of $\mathcal{O}_{\alpha,\beta}(\mathbb{M}(n))$ if and only if $\alpha'\beta' = \alpha\beta$ or $(\alpha\beta)^{-1}$.*

PROOF. It remains to show the “only if” part. Suppose that τ is a 2-cocycle for $\mathcal{O}_{\alpha,\beta}(\mathbb{M}(n))$ such that there exists a bialgebra isomorphism

$$\varphi : \mathcal{O}_{\alpha',\beta'}(\mathbb{M}(n)) \xrightarrow{\cong} \mathcal{O}_{\alpha,\beta}(\mathbb{M}(n))^{\tau},$$

which may be regarded as

$$\varphi : M(C_n, \sigma_{\alpha',\beta'}) \xrightarrow{\cong} M(C_n, (\sigma_{\alpha,\beta})^{\tau}).$$

From a simple observation, it follows that the restriction of φ to C_n gives an automorphism of C_n .

By the Noether–Skolem theorem, there exists a linear isomorphism $\psi : V_n \xrightarrow{\cong} V_n$ which is “semi-colinear” with respect to φ in the sense that the diagram

$$\begin{array}{ccc} V_n & \xrightarrow{\psi} & V_n \\ \varrho \downarrow & & \downarrow \varrho \\ V_n \otimes C_n & \xrightarrow{\psi \otimes \varphi} & V_n \otimes C_n \end{array}$$

commutes, where ϱ denotes the canonical comodule structure, i.e. $\varrho(e_j) = \sum_i e_i \otimes x_{ij}$. Let σ denote the braiding on $M(C_n, \sigma_{\alpha',\beta'})$ which is the pull-back of $(\sigma_{\alpha,\beta})^{\tau}$ through φ . Then the last commutative diagram makes the following commute.

$$\begin{array}{ccc} V_n \otimes V_n & \xrightarrow{\psi \otimes \psi} & V_n \otimes V_n \\ R_{\sigma} \downarrow & & \downarrow R_{(\sigma_{\alpha,\beta})^{\tau}} \\ V_n \otimes V_n & \xrightarrow{\psi \otimes \psi} & V_n \otimes V_n \end{array}$$

Note further that $R_{(\sigma_{\alpha,\beta})^{\tau}} = P_{\tau} R_{\alpha,\beta} P_{\tau}^{-1}$, where

$$P_{\tau}(e_k \otimes e_{\ell}) = \sum_{i,j} \tau(x_{ik}, x_{j\ell}) e_i \otimes e_j.$$

Then we see that R_σ satisfies the following conditions:

- (a) R_σ is a right $\mathcal{O}_{\alpha',\beta'}(\mathbb{M}(n))$ comodule automorphism;
- (b) R_σ satisfies the braid condition;
- (c) $R_\sigma^2 = (\alpha\beta - 1)R_\sigma + \alpha\beta$.

Condition (a) is equivalent to

$$R_\sigma \in \text{End}_{S(n,2)}(V_n^{\otimes 2}),$$

where $S(n, 2)$ is taken with respect to α', β' (Section 11). This means that R_σ is in the double centralizer of $R_{\alpha',\beta'}$. It is known that the double centralizer of a linear transformation of a finite dimensional vector space consists of all polynomials of the linear transformation.

Since $R_{\alpha',\beta'}$ satisfies a quadratic equation, this implies that

$$(a') \quad R_\sigma \text{ is a linear combination of } 1, R_{\alpha',\beta'}.$$

If we look for a linear map R_σ satisfying (a'), (b) and which can be extended to a braiding on $\mathcal{O}_{\alpha',\beta'}(\mathbb{M}(n))$, we see that R_σ should be equal, up to non-zero scalar multiplication, to $R_{\alpha',\beta'}$ or $R_{\alpha',\beta'} + 1 - \alpha'\beta'$.

Suppose first $R_\sigma = cR_{\alpha',\beta'}$, with $c \in k^\times$. Then, by Proposition 10.3 (b),

$$R_\sigma^2 = c^2 R_{\alpha',\beta'}^2 = c^2(\alpha'\beta' - 1)R_{\alpha',\beta'} + c^2\alpha'\beta'.$$

Since it follows from (c) that

$$R_\sigma^2 = (\alpha\beta - 1)R_\sigma + \alpha\beta = c(\alpha\beta - 1)R_{\alpha',\beta'} + \alpha\beta,$$

we have $c^2(\alpha'\beta' - 1) = c(\alpha\beta - 1)$ and $c^2\alpha'\beta' = \alpha\beta$, whence, by eliminating c ,

$$\frac{(\alpha\beta - 1)^2}{\alpha\beta} = \frac{(\alpha'\beta' - 1)^2}{\alpha'\beta'}$$

or $(\alpha\beta - \alpha'\beta')(\alpha\beta\alpha'\beta' - 1) = 0$.

The same equation is obtained in the other case. □

REMARK 12.13. The proof shows that the braidings on $\mathcal{O}_{\alpha,\beta}(\mathbb{M}(n))$ are exhausted essentially by the two of $\sigma_{\alpha,\beta}$ and the pull-back $\sigma'_{\alpha,\beta}$ of $\sigma_{\alpha^{-1},\beta^{-1}}$ through the isomorphism $\mathcal{O}_{\alpha,\beta}(\mathbb{M}(n)) \cong \mathcal{O}_{\alpha^{-1},\beta^{-1}}(\mathbb{M}(n))$ (cf. the proof of Proposition 12.11).

Note that $R_{\sigma'_{\alpha,\beta}} = R_{\alpha,\beta} + 1 - \alpha\beta$.

In a similar way:

COROLLARY 12.14. *If $q^2 \neq 1$, then $\mathcal{O}_q(\text{GL}(n))$ cannot be a cocycle deformation of any commutative Hopf algebra.*

13. (2 × 2) R-Matrices

By a (2 × 2) *R-matrix*, we mean an invertible matrix R in $M_2(k) \otimes M_2(k)$ which satisfies the braid condition. We ask:

How many (2 × 2) *R*-matrices exist?

For such a matrix R , we define the k -bialgebra $\mathcal{O}_R(M(2))$ generated by the entries $x_{11}, x_{12}, x_{21}, x_{22}$ in $X = (x_{ij})_{i,j \in \{1,2\}}$ with the relation $X^{(2)}R = RX^{(2)}$.

Let $C_2 := M_2(k)^*$, as in Example 12.6. The (2 × 2) *R*-matrices R are in one-to-one correspondence with the invertible bilinear forms $\sigma : C_2 \times C_2 \rightarrow k$, which satisfy the Yang–Baxter condition (12-2), in such a way that

$$R_{(ij),(kl)} = \sigma(x_{jk}, x_{il}). \tag{13-1}$$

Furthermore, we have $\mathcal{O}_R(M(2)) = M(C_2, \sigma)$. Hence, $\mathcal{O}_R(M(2))$ is a braided bialgebra.

Kauffman classifies the *R*-matrices of the form:

$$\begin{pmatrix} n & & & \\ & r & d & \\ & s & \ell & \\ & & & p \end{pmatrix} \tag{13-2}$$

(where rows and columns are indexed by (11), (12), (21), (22)). This is invertible if and only if $p, n \neq 0$ and $r\ell - ds \neq 0$.

REMARK 13.1. (a) A matrix of the form (13-2) satisfies the braid condition if and only if the following relations hold:

$$\begin{aligned} r\ell d &= r\ell s = r\ell(r - \ell) = 0, \\ p^2\ell &= p\ell^2 + \ell ds, \\ n^2\ell &= n\ell^2 + \ell ds, \\ p^2r &= pr^2 + rds, \\ n^2r &= nr^2 + rds. \end{aligned}$$

(b) The following are examples of *R*-matrices of this form:

$$\begin{pmatrix} n & & & \\ & s & d & \\ & & & p \end{pmatrix}, \quad \begin{pmatrix} \gamma & & & \\ & \beta & \alpha & \\ & & \alpha\beta-1 & \\ & & & \delta \end{pmatrix}, \tag{13-3}$$

where $\gamma, \delta \in \{\alpha\beta, -1\}$ and $\alpha, \beta, n, p, d, s \in k^\times$ are arbitrary. For $\gamma := \delta := \alpha\beta$, we get $R_{\alpha,\beta}$.

The bialgebras $\mathcal{O}_R(M(2))$ for these *R*-matrices are not yet investigated except for $R_{\alpha,\beta}$. However, for the following two examples of *R*-matrices, the bialgebras $\mathcal{O}_R(M(2))$ have been investigated.

EXAMPLE 13.2 (Takeuchi–Tambara). Assume $\text{char}(k) \neq 2$. For $q \in k^\times$, the matrix

$$R := 1/2 \begin{pmatrix} 2 - (q-1)^2 & & & (q-1)^2 \\ & 1 - q^2 & 1 + q^2 & \\ & 1 + q^2 & 1 - q^2 & \\ (q+1)^2 & & & 2 - (q+1)^2 \end{pmatrix}$$

is invertible and satisfies the braid condition and the relation

$$(R - I)(R + q^2 I) = 0.$$

If $q^2 \neq -1$, then R is diagonalizable to $\text{diag}(1, 1, -q^2, -q^2)$.

EXAMPLE 13.3 (Suzuki). For $\alpha, \beta \in k^\times$, write

$$R := \begin{pmatrix} & & \alpha \\ & \beta & \\ \alpha & & \beta \end{pmatrix}.$$

The corresponding invertible form $\tau_{\alpha, \beta} : C_2 \times C_2 \rightarrow k$ according to (13-1) is given by

$$\tau_{\alpha, \beta}(x_{ij}, x_{k\ell}) = \begin{cases} \alpha & \text{if } (ij, k\ell) \in \{(12, 12), (21, 21)\}, \\ \beta & \text{if } (ij, k\ell) \in \{(12, 21), (21, 12)\}, \\ 0 & \text{otherwise.} \end{cases}$$

Suppose $\alpha^2 \neq \beta^2$. Then $\mathcal{O}_R(M(2)) = M(C_2, \tau_{\alpha, \beta})$ is independent of the choice of α, β . Denote by B this bialgebra. Then

- (a) B is generated by $x_{11}, x_{12}, x_{21}, x_{22}$ with relations $x_{11}^2 = x_{22}^2$, $x_{12}^2 = x_{21}^2$, and $x_{ij}x_{\ell m} = 0$, for $i - j \not\equiv \ell - m \pmod{2}$;
- (b) B is cosemisimple;
- (c) the maps $\tau_{\alpha, \beta}$, for $\alpha, \beta \in k^\times$, exhaust the braidings on B .

14. The Quantum Frobenius Map and Related Topics

The quantum Frobenius map for $\text{GL}_q(n)$ was introduced by Parshall–Wang (1991) and independently by myself (1992). Assume q is a root of unity, let ℓ be the order of q^2 and put $\varepsilon = q^{\ell^2}$. We have

| | | |
|---------------|--------------------|-------------------|
| | ℓ odd | ℓ even |
| $q^\ell = 1$ | $\varepsilon = 1$ | \times |
| $q^\ell = -1$ | $\varepsilon = -1$ | $\varepsilon = 1$ |

PROPOSITION 14.1. *If $X = (x_{ij})$ is a q -matrix, then $X^{(\ell)} = (x_{ij}^\ell)$ is an ε -matrix.*

By associating $X^{(\ell)}$ to X , we get a homomorphism of quantum groups

$$\mathcal{F}: \text{GL}_q(n) \rightarrow \text{GL}_\varepsilon(n)$$

which is called the quantum Frobenius map. The corresponding Hopf algebra map

$$\mathcal{O}(\mathcal{F}): \mathcal{O}_\varepsilon(\text{GL}(n)) \rightarrow \mathcal{O}_q(\text{GL}(n))$$

is injective and free of rank ℓ^{n^2} . If $q^\ell = 1$ (hence ℓ odd), then the image of $\mathcal{O}(\mathcal{F})$ is contained in the center. Let $\text{GL}'_q(n)$ be the quantum subgroup of $\text{GL}_q(n)$ represented by the quotient Hopf algebra $\mathcal{O}_q(\text{GL}(n))/\mathcal{O}_q(\text{GL}(n))\mathcal{O}(\text{GL}(n))^+$ which is ℓ^{n^2} -dimensional. We may think of it as the kernel of \mathcal{F} , and we obtain an exact sequence of quantum groups

$$1 \rightarrow \text{GL}'_q(n) \rightarrow \text{GL}_q(n) \xrightarrow{\mathcal{F}} \text{GL}(n) \rightarrow 1. \tag{14-1}$$

A finite quantum subgroup of $\text{GL}_q(n)$ means a finite dimensional quotient Hopf algebra of $\mathcal{O}_q(\text{GL}(n))$. If q has an odd order, $\text{GL}'_q(n)$ is such an example. Recently, E. Müller has determined all finite subgroups of $\text{GL}_q(n)$. We describe his results in the following.

If q is not a root of unity, all finite subgroups of $\text{GL}_q(n)$ are contained in the canonical torus T . We assume q is a root of unity of odd order ℓ and k is an algebraically closed field of characteristic 0.

Let I be a subset of $I_0 = \{(i, i+1), (i+1, i) \mid i = 1, 2, \dots, n-1\}$. A quantum subgroup $P_{q,I}$ of $\text{GL}_q(n)$ is determined by the following condition: If $i \leq a, a+1 \leq j$ for some $(a, a+1) \notin I$ or if $j \leq b, b+1 \leq i$ for some $(b+1, b) \notin I$, then the (i, j) component is zero.

EXAMPLE 14.2. $n = 5, I = \{(1, 2), (3, 4), (2, 1), (5, 4)\}$.

$$P_{q,I} = \left(\begin{array}{cc|ccc} * & * & 0 & 0 & 0 \\ * & * & 0 & 0 & 0 \\ \hline 0 & 0 & * & * & 0 \\ 0 & 0 & 0 & * & 0 \\ 0 & 0 & 0 & * & * \end{array} \right).$$

Let s be the number of i such that $(i, i+1) \notin I$ and $(i+1, i) \notin I$. In the above example, $s = 2$. Then $P_{q,I}$ factors as the direct product of s blocks. By associating the q -determinant with each block, we get a homomorphism of quantum groups

$$D_q: P_{q,I} \rightarrow (G_m)^s.$$

When $q = 1$, we write $P_I = P_{1,I}$ and $D = D_1$. Thus

$$D: P_I \rightarrow (G_m)^s.$$

We have the following commutative diagram of quantum groups with exact rows:

$$\begin{array}{ccccccc}
 1 & \longrightarrow & P'_{q,I} & \longrightarrow & P_{q,I} & \xrightarrow{\mathcal{F}} & P_I & \longrightarrow & 1 \\
 & & \downarrow D'_q & & \downarrow D_q & & \downarrow D & & \\
 1 & \longrightarrow & (\ell G_m)^s & \longrightarrow & (G_m)^s & \xrightarrow{\ell\text{-th power}} & (G_m)^s & \longrightarrow & 1
 \end{array}$$

where $P'_{q,I} = P_{q,I} \cap \text{GL}'_q(n)$ and D'_q denotes the map induced by D_q .

Let G be a finite quantum subgroup of $\text{GL}_q(n)$. The image $\mathcal{F}(G)$ which is a finite algebraic subgroup of $\text{GL}(n)$ is identified with a finite (abstract) subgroup Γ of $\text{GL}_n(k)$, since k is algebraically closed of characteristic 0. The exact sequence (14-1) induces an exact sequence of finite quantum groups:

$$1 \rightarrow G' \rightarrow G \xrightarrow{\mathcal{F}} \Gamma \rightarrow 1 \tag{14-2}$$

The following are key results of Müller.

PROPOSITION 14.3. *If G' is a quantum subgroup of $\text{GL}'_q(n)$, there are a subset I of I_0 and a quotient group Q' of $(\ell G_m)^s$ such that*

$$G' = \text{Ker}\left(P'_{q,I} \xrightarrow{D'_q} Q'\right).$$

PROPOSITION 14.4. *Let G be a finite quantum subgroup of $\text{GL}_q(n)$ and let I be a subset of I_0 . Assume $\ell > n^2/4$. If $G' \subset P'_{q,I}$, then $G \subset P_{q,I}$. In particular, we have $\Gamma \subset P_I(k)$.*

If we are in this situation, we have the following commutative diagram of quantum groups with exact rows:

$$\begin{array}{ccccccc}
 1 & \longrightarrow & G' & \longrightarrow & G & \xrightarrow{\mathcal{F}} & \Gamma & \longrightarrow & 1 \\
 & & \cap & & \cap & & \cap & & \\
 1 & \longrightarrow & P'_{q,I} & \longrightarrow & P_{q,I} & \xrightarrow{\mathcal{F}} & P_I & \longrightarrow & 1 \\
 & & \downarrow D'_q & & \downarrow D_q & & \downarrow D & & \\
 1 & \longrightarrow & (\ell G_m)^s & \longrightarrow & (G_m)^s & \xrightarrow{\ell\text{-th power}} & (G_m)^s & \longrightarrow & 1 \\
 & & \downarrow & \text{push out} & \downarrow & & \parallel & & \\
 1 & \longrightarrow & Q' & \longrightarrow & Q & \longrightarrow & (G_m)^s & \longrightarrow & 1
 \end{array} \tag{14-3}$$

By an easy diagram-chasing, we conclude there is a homomorphism of (abstract) groups $\alpha_G: \Gamma \rightarrow Q(k)$ such that the diagram

$$\begin{array}{ccc}
 G & \longrightarrow & \Gamma \\
 \downarrow D_q & \nearrow \alpha_G & \downarrow D \\
 Q & \longrightarrow & (G_m)^s
 \end{array}$$

commutes.

Conversely, consider a set of data as follows:

- $I \subset I_0$
- Q' a quotient group of $({}_\ell G_m)^s$,
- G' as in Proposition 14.3
- $\Gamma \subset P_I(k)$ a subgroup,
- Q as in (14-3),
- $\alpha: \Gamma \rightarrow Q(k)$ a group homomorphism such that

$$\begin{array}{ccc}
 & & \Gamma \\
 & \nearrow \alpha & \downarrow D \\
 Q & \longrightarrow & (G_m)^s
 \end{array}$$

commutes.

We have the following main result.

THEOREM 14.5 (E. Müller). *With the set of data above, let*

$$G = \text{Ker} \left(\mathcal{F}^{-1}(\Gamma) \cap P_{q,I} \begin{array}{c} \xrightarrow{\alpha_{\mathcal{F}}} \\ \xrightarrow{D_q} \end{array} Q \right).$$

Then G is a finite quantum subgroup of $\text{GL}_q(n)$ which fits the exact sequence (14-2). If $\ell > n^2/4$, then these G for all possible previous sets of data exhaust all finite quantum subgroups of $\text{GL}_q(n)$.

Finally, we mention the following result of E. Letzter concerning $\text{Spec } \mathcal{O}_q(\text{GL}(n))$, the set of prime ideals of the non-commutative ring $\mathcal{O}_q(\text{GL}(n))$. We assume q is a root of unity of odd order ℓ . Multiplication of a row or a column of a q -matrix by a constant yields a q -matrix. Considering multiplication of all rows and columns of the generating q -matrix by q , one obtains a group action of $(\mathbb{Z}/\ell)^{2n-1}$ on $\mathcal{O}_q(\text{GL}(n))$ as ring automorphisms. The image of $\mathcal{O}(\mathcal{F})$ is contained in the

invariants by this action. Hence the Frobenius map \mathcal{F} induces a map

$$\begin{aligned} (\mathrm{Spec} \mathcal{O}_q(\mathrm{GL}(n)))/(\mathbb{Z}/\ell)^{2n-1} &\rightarrow \mathrm{Spec} \mathcal{O}(\mathrm{GL}(n)) \\ P &\mapsto \mathcal{O}(\mathcal{F})^{-1}(P). \end{aligned}$$

E. Letzter has shown that this map is bijective.

15. References and Notes

For the general concepts of the theory of Hopf algebras, see:

- S. Montgomery, “Hopf algebras and their actions on rings”, CBMS Reg. Conf. Ser. in Math. 82 (1993), AMS.
- M. Sweedler, “Hopf algebras”, Benjamin, New York, 1969.

Section 1. Proposition 1.3 is due to Umeda and Wakayama (see below under Section 3). An elementary approach (slightly different from ours) to (2×2) q -matrices is given in

- Yu. I. Manin, “Quantum Groups and Noncommutative Geometry,” CRM, Montreal, 1988.

Section 2. These results are due to

- L. H. Kauffman, “Knots and Physics”, World Scientific, 1991, pp. 124–136.

Section 3. The result is contained in

- H. Ewen, O. Ogievetsky, J. Wess, “Quantum matrices in two dimensions”, Letters in Math. Physics 22 (1991), 297–305;
- S. P. Vokos, B. Zumino, J. Wess, “Analysis of the basic matrix representation of $\mathrm{GL}_q(2, \mathbb{C})$ ”, Z. Phys. C-Particles and Fields 48 (1990), 65–74.

The proof given here is due to

- T. Umeda, M. Wakayama, “Powers of (2×2) quantum matrices”, Comm. Alg. 21 (1993), 4461–4465.

Section 4. The notion of $(n \times n)$ q -matrices was first introduced by Drinfeld in the following paper, although he did not use this terminology.

- V. G. Drinfeld, “Quantum groups”, Proc. ICM Berkeley, 1986, pp. 798–820.

In the following paper, the celebrated construction of $A(R)$ was given and applied to define the q -function algebras $\mathrm{Func}_q(\mathrm{GL}(n, \mathbb{C}))$, $\mathrm{Func}_q(\mathrm{SL}(n, \mathbb{C}))$.

- L. D. Faddeev, N. Yu. Reshetikhin, L. A. Takhtajan, “Quantization of Lie groups and Lie algebras”, Leningrad Math. J. 1 (1990), 193–225.

Around 1987, Woronowicz reached the same notion from the viewpoint of operator algebras. See

- S. L. Woronowicz, “Twisted $SU(2)$ -group”, Publ. RIMS, Kyoto Univ. 23 (1987), 117–181.

Afterwards, it has become clear gradually that the “linear algebra” can be quantized by using q -matrices. In the following paper, the FRT construction of $A(R)$ was reformulated from the coalgebraic viewpoint by using the notion of “cocentralizers” and “conormalizers”, and it was applied to clarify the relations between R_q , $\bigwedge_q(V_n)$, $S_q(V_n)$ and $\mathcal{O}_q(M(n))$.

- M. Takeuchi, “Matric bialgebras and quantum groups”, Israel J. Math. 72 (1990), 232–251.

The q -linear algebra including the Laplace expansion is discussed thoroughly in the following two articles.

- E. Taft, J. Towber, “Quantum deformations of flag schemes and Grassman schemes I”, J. Alg. 142 (1991), 1–36;
- B. Parshall, J.-P. Wang, “Quantum linear groups”, Memoirs of the AMS 439 (1991).

Section 5. The result is due to

- J. Zhang, “The quantum Cayley–Hamilton theorem”, preprint, 1991.

Section 6. The results of this section are from

- L. H. Kauffman, “Knots and Physics”, World Scientific, 1991, pp. 161–173.

Section 7. These results are from

- M. Takeuchi, “Hopf algebra techniques applied to the quantum group $U_q(\mathfrak{sl}_2)$ ”, Contemp. Math. 134 (1992), 309–323.

Section 8. For Proposition 8.3 refer to § 5, especially to Prop. 5.3, Thm. 5.4 of

- M. Takeuchi, “ q -Representations of quantum groups”, Canad. Math. Soc. Conf. Proc. 16 (1995), 347–385.

Section 9. The paper just noted, in which a morphism $\varrho : G \rightarrow GL_q(n)$ is called a q -representation of the quantum group G , determines the q -representations, the one-representations of $SL_q(n)$, and also the automorphisms of $GL_q(n)$ and of $SL_q(n)$.

What is stated in the text is part of these results, namely the results in the case where q is not a root of unity. To discuss the general case, we have to extend the duality of $U_q(\mathfrak{sl}_n)$ stated in Section 7 to that of the Lusztig form $\tilde{U}_q(\mathfrak{sl}_n)$. This technical device is investigated thoroughly in the next papers.

- M. Takeuchi, “Some topics on $GL_q(n)$ ”, J. Alg. 147 (1992), 379–410;
- M. Takeuchi, “The quantum hyperalgebra of $SL_q(2)$ ”, Proc. Symp. Pure Math. 56(2) (1994), 121–134.

Section 10. The concept of (α, β) -matrices is due to

- M. Takeuchi, “A two-parameter quantization of $GL(n)$ ”, Proc. Japan Acad. 66, Ser. A (1990), 112–114.

Quantization with more parameters is also investigated by many mathematicians.

Section 11. The q -Schur algebra was introduced in

- R. Dipper, G. James, “The q -Schur algebra”, Proc. London Math. Soc. (3) 59 (1989), 23–50.

Its relations with quantum groups have been clarified in

- R. Dipper, S. Donkin, “Quantum GL_n ”, Proc. London Math. Soc. (3) 63 (1991), 165–211.

The last remark of this section is due to

- Du, B. Parshall, J.-P. Wang, “Two-parameter quantum linear groups and the hyperbolic invariance of q -Schur algebras”, J. London Math. Soc. (2) 44 (1991), 420–436.

Dipper and James have shown that there are interesting relations between the representation of the q -Schur algebra, where q is a power of a prime, and those of $GL_n(\mathbb{F}_q)$. Although their arguments are very complicated, they can be simplified considerably if we discuss only the unipotent representations.

For this result, refer to

- M. Takeuchi, “Relations of representations of quantum groups and finite groups”, Advances in Hopf algebras, L.N. pure and appl. math. Vol. 158, pp. 319–326, Marcel Dekker, 1994;
- M. Takeuchi, “The group ring of $GL_n(\mathbb{F}_q)$ and the q -Schur algebra”, J. Math. Soc. Japan 48 (1996), 259–274.

Section 12. The cocycle deformation A^σ and the construction of $M(C, \sigma)$ were introduced in

- Y. Doi, “Braided bialgebras and quadratic bialgebras”, Com. Alg. 21 (1993), 1731–1749.

As the dual notion of quasi-triangular bialgebras due to Drinfeld, the braided bialgebra was introduced, for example, in

- T. Hayashi, “Quantum groups and quantum determinants”, J. Alg. 152 (1992), 146–165;
- R. G. Larson, J. Towber, “Two dual classes of bialgebras related to the concepts of “quantum groups” and “quantum Liealgebra”, Com. Alg. 19 (1991), 3295–3345.

The results stated in this section are taken from

- M. Takeuchi, “Cocycle deformations of coordinate rings of quantum matrices”, *J. Alg.* 189 (1997), 23–33.

Section 13. The results of this section are taken from

- L. H. Kauffman, “Knots and Physics”, World Scientific, 1991, pp. 316;
- M. Takeuchi and D. Tambara, “A new one-parameter family of (2×2) matrix bialgebras”, *Hokkaido Math. J.* 21 (1992), 405–419;
- Satoshi Suzuki, “A family of braided cosemisimple Hopf algebras of finite dimension”, *Tsukuba J. Math.* 22 (1998), 1–30

Section 14. The results of this section come from

- E. Müller, “Finite subgroups of the quantum general linear group”, *Proc. London Math. Soc.* (3) 81 (2000), 190–210;
- E. S. Letzter, “On the quantum Frobenius map for general linear groups”, *J. Algebra* 179 (1996), 115–126.

MITSUHIRO TAKEUCHI
NOTES TAKEN BY BERND STRÜBER
INSTITUTE OF MATHEMATICS
UNIVERSITY OF TSUKUBA
TSUKUBA-SHI IBARAKI, 305-8571 JAPAN